

# Rubber **Seals**

***Techné***  
— LA PERFORMANCE AU QUOTIDIEN



**Techné**

*techne.fr*

- **Direct and easy access to our stock, on our main range of products.**
- **Technical information, function principles, assembling conditions etc.**
- **Material data sheets on line**
- **News from Techné**

Join us on [www.techne.fr](http://www.techne.fr)

All information in this brochure are given only for information and Techné cannot be liable for any mistakes.  
Any information in this catalogue is subject to change without notice.

# Editorial



Every day for the past 30 years, Techné has developed its knowledge in sealing and sliding parts.

Technical and human investments coupled with external growth allow us today, to be a reliable partner for many renowned companies, without compromising the historical values of a family group.

We invest in Asia as well as in Europe to be able to continually modernise our production units, in order to keep up with the evolution of our customers.

We implement the most advanced technologies like surface treatments to increase the eco-efficiency of your systems.

We set up a development policy which is respectful both of employees and of the environment.

We are developing today the technical know-how that you will need tomorrow.

From the part's design to the delivery, a whole team is in motion to ensure daily performance.

Marie Fontaines,  
CEO of Techné group

# Table of content

---

## PART I



## Know-how

6 Processes

18 Development

26 Materials

50 Coatings

## PART II



## Standard products

62 O-Rings

78 JT4 X-Rings

84 Backup Rings (BAE)

94 Rubber Cord

96 JR Fitting Seals

100 Bonded Seals

108 Triclover Clamp Seals

114 D-Ring - milk coupling Seals

118 SMS Seals

122 Macon Seals

126 Aseptic O-Rings DIN 11864

# Part I Know-how

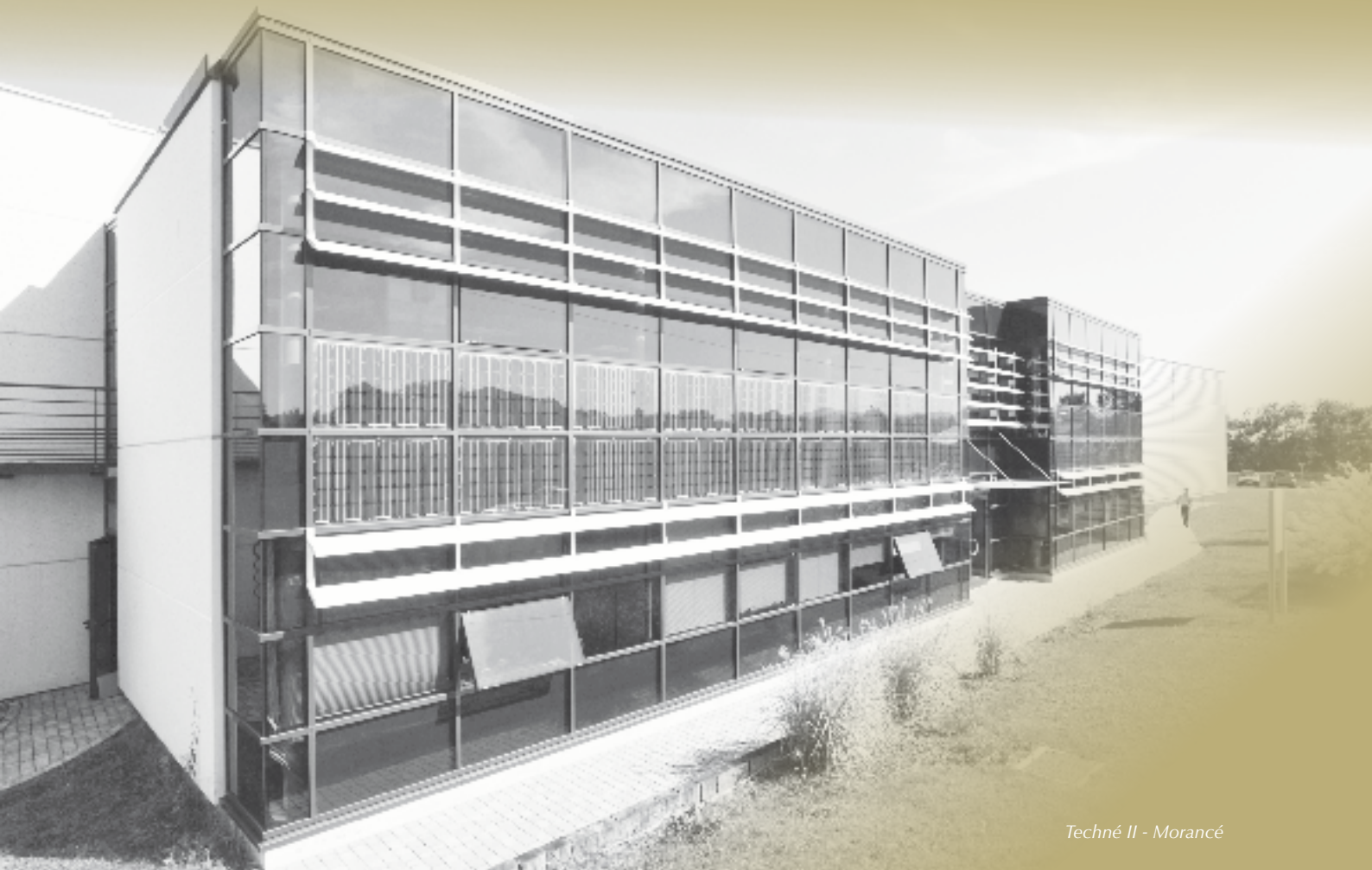

*The information in this catalogue is based on the experience gained by Techné in the last decade of research on the development and manufacture of seals and other rubber components. It represents the current state of our knowledge and know-how.*

*The sealing properties of the seals in this catalogue do not rely only on the component itself, but on the other parameters such as the applied pressure, contact area, operating temperature, mechanical stress, media to be sealed and any kind of outside dirt.*

*Because of those high numbers of parameters, it is not possible to give general statements on the function of the products in this catalogue.*

*The information in this catalogue only represents recommended values that are not true in every application that is why we recommend contacting us. In cases with high or special loads we strongly recommend to contact our technical department. Moreover it will be essential to perform checking trials in order to approve the good functionality of the sealing system.*

*In the context of product optimisation, we reserve the right to change, without prior notice, our product range, tolerances, materials and manufacturing process as well as the information mentioned in this catalogue.*

*All previous issues become obsolete on publication of this issue of catalogue.*

*Duplication in any form requires official approval from Techné, 40 allée des haies, 69480 Morancé.*

# Processes

Development 18

Materials 26

Coatings 50

## 1. Processes

- 6 Moulding process
- 9 Moulding tolerances
- 10 Deflashing process
- 11 Cutting process
- 12 Machining process
- 13 Comparison of methods

## Quality monitoring

- 14 Dimensional inspection
- 15 Inspection
- 16 Packaging

# 1. PROCESSES

## a) Moulding process

### ✓ Injection

#### PREPARATION

The material is received in the form of raw rubber, called "masterbatch". If necessary, curing agents, accelerators and activators are mixed in the raw rubber with the help of two rollers. After several runs through the rollers, the material acquires its homogeneity, is calibrated in thickness and cut into strips.

#### VULCANISATION

A strip of elastomer material is inserted into an endless conveyer screw. The mixture is then heated and liquefied. Afterwards it is injected under pressure in feeding channels to go and fill up the cavities of the tool. Vulcanisation can now take place. Vulcanisation (or reticulation) is the trigger of the chemical reactions during which the monomer bases bind and form a cross-linked chain. The solidified result forms a cluster consisting of the parts and the feeding channels. During the finishing process, the parts will need to be separated from the rubber residues of channels and deflashed.

#### INJECTION TOOLS

The cavities of the injection tool are fed with material thanks to secondary feeding channels via an injection point, or feeding area. These channels are themselves connected to the main feeding channel which is connected to the press's injection nozzle. These tools are usually equipped with a thermoregulation system in order to maintain a homogeneous temperature in the different cavities.

### The masterbatch

It consists of an elastomer base mixed with plasticizers and carbon black (or mineral fillers, usually for coloured mixtures). Semi-finished material acquires its properties of process-ability and hardness. Curing agents, accelerators and activators will need to be added for the moulding process. The use of masterbatch can extend the storage period of raw material.

The injection point or feeding area may leave a raised mark or a hollow depending on the dimensions of the part. The maximum sizes are listed in the ISO 3601-3:2005 grade N.

#### TOLERANCES

The tolerances on finished parts are in accordance with ISO 3302 grade M2, see table on page 9.

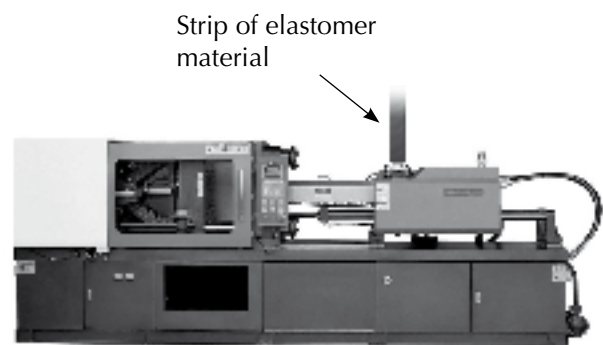

Injection machine

#### WORKFLOW

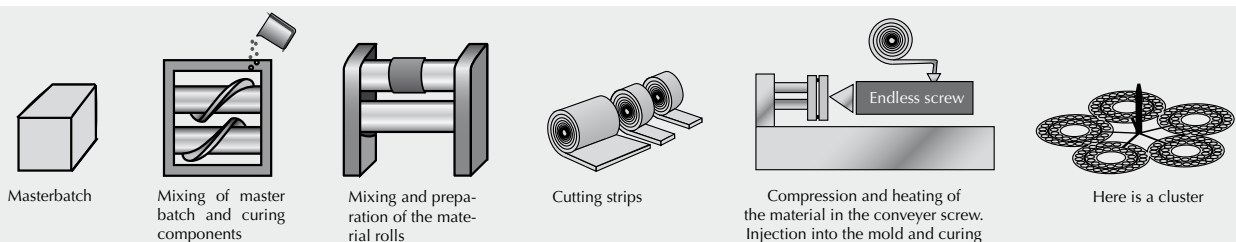



## ✓ Compression

### PREPARATION

The procedure of reception and mixing of the masterbatch is the same as by injection moulding.

The masterbatch is cut into strips. The weight of those strips is 100% controlled to ensure that the operators have the exact needed quantity.

### VULCANISATION

With the help of a specific tool, the operator places the strips into the open mould. When the mould shuts the vulcanisation begins.

Vulcanisation (or reticulation) is the trigger of the chemical reactions during which the monomer bases bind and form a cross-linked chain. The solidified result forms a sheet consisting of the parts and a linking membrane (also called "flash").

### TOLERANCES

The tolerances on finished parts are in accordance with ISO 3302 grade M1 or M2 depending of customers' needs, see table on page 9.

### COMPRESSION TOOLS

Compression tools are usually composed of the plates (upper and lower plate). The cavities are machined without any feeding channels, thereby increasing the number of cavities.

The mould's temperature is regulated by resistors in contact with the plates. Thanks to the simplicity of its design, the tool easily gets a homogeneous temperature.

The mould is positioned horizontally (vertical opening) in order to guarantee an accurate closing : parting line offset due to tool upper and lower plates misalignment is minimal. To create complicated shapes, theoretically un-extractable, Techné offers a multi-plates tool conception.

## Rubber cutting lozenge

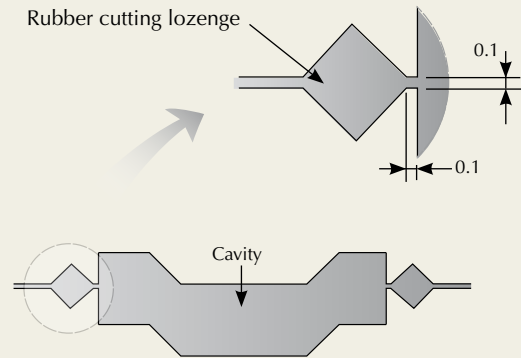

For a moulded part, Techné guarantees a maximum remaining flash burr of 0.1x0.1 mm on parting line locations.

A thin interspace between the tool plates is purposely created around the cavities, so that the material can fill all the cavities and the material overflow can escape.

Lozenge profiles placed around the cavities will ease the deflashing operation. These are called "rubber cutting lozenges".

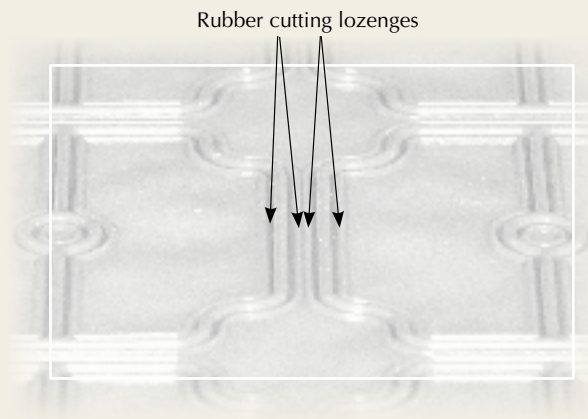

Focus on the sheet

### WORKFLOW

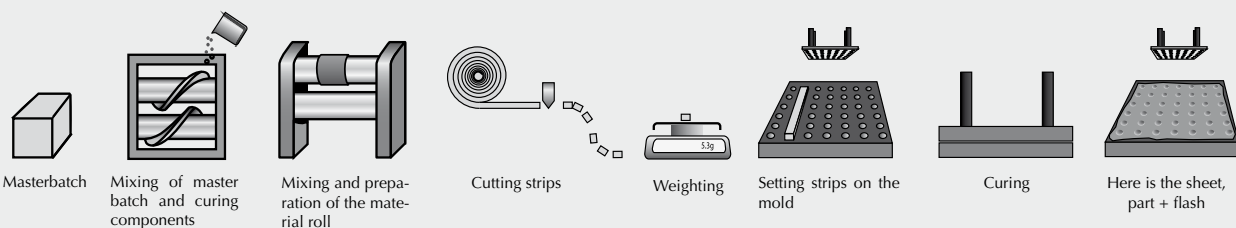

## ✓ Transfer moulding

Transfer moulding uses a press similar to the one used for compression moulding.

It is generally chosen to manufacture parts with bounded or over-moulded metal inserts (See TBS bonded seals page 100).

### PREPARATION

To obtain such parts, a 3-plates tool is manufactured: a lower plate, a middle plate and a perforated upper plate. The cavities are machined in the middle and lower plates.

### VULCANISATION

The metal inserts are placed on the lower plate. The middle plate is placed on the latter. The rubber strips are placed on the middle plate just above the holes, which are used as injections feeding channels. The upper plate then shuts the tool.

As a result of the closing pressure, and of the temperature, the material melts, passes through the holes and fills the cavities.



*Techné bonded seals*

### TOLERANCES

The tolerances on finished parts are in accordance with ISO 3302 grade M2, see table on page 9.

### WORKFLOW

Similar to compression moulding concerning the preparation of the material, it differs however in the moulding method. See Techné bonded seal workflow below.

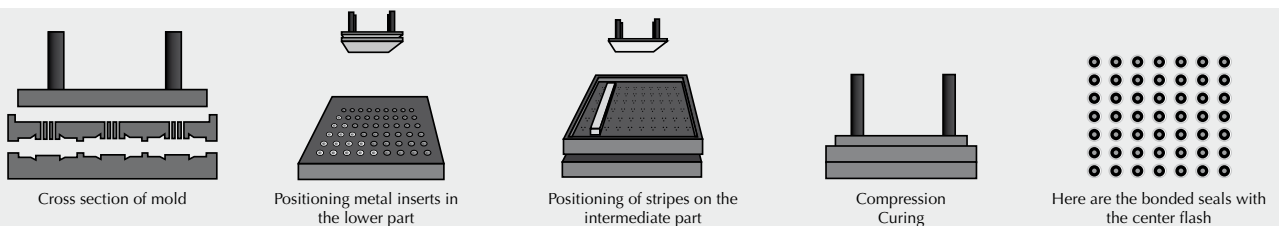

## b) Moulding tolerances

Techné's moulded parts are made according to ISO 3302. Depending on the selected process, feasibility and customer requirements, a M1 grade (precision part) or a M2 grade will be applied. Even tighter tolerances can be proposed on specific request.

### TOLERANCES ACCORDING TO ISO 3302 STANDARD

Dimensions (mm)	ISO 3302 M1		ISO 3302 M2	
	F ±	C ±	F ±	C ±
0 - 4	0.08	0.10	0.10	0.15
4 - 6.3	0.10	0.12	0.15	0.20
6.3 - 10	0.10	0.15	0.20	0.20
10 - 16	0.15	0.20	0.20	0.25
16 - 25	0.20	0.20	0.25	0.35
25 - 40	0.20	0.25	0.35	0.40
40 - 63	0.25	0.35	0.40	0.50
63 - 100	0.35	0.40	0.50	0.70
100 - 160	0.40	0.50	0.70	0.80
> 160	0.3%	0.4%	0.5%	0.7%

*C* : Tolerances impacted by the closure of the mold  
*F* : Fixed tolerances.

Compression molding  
press

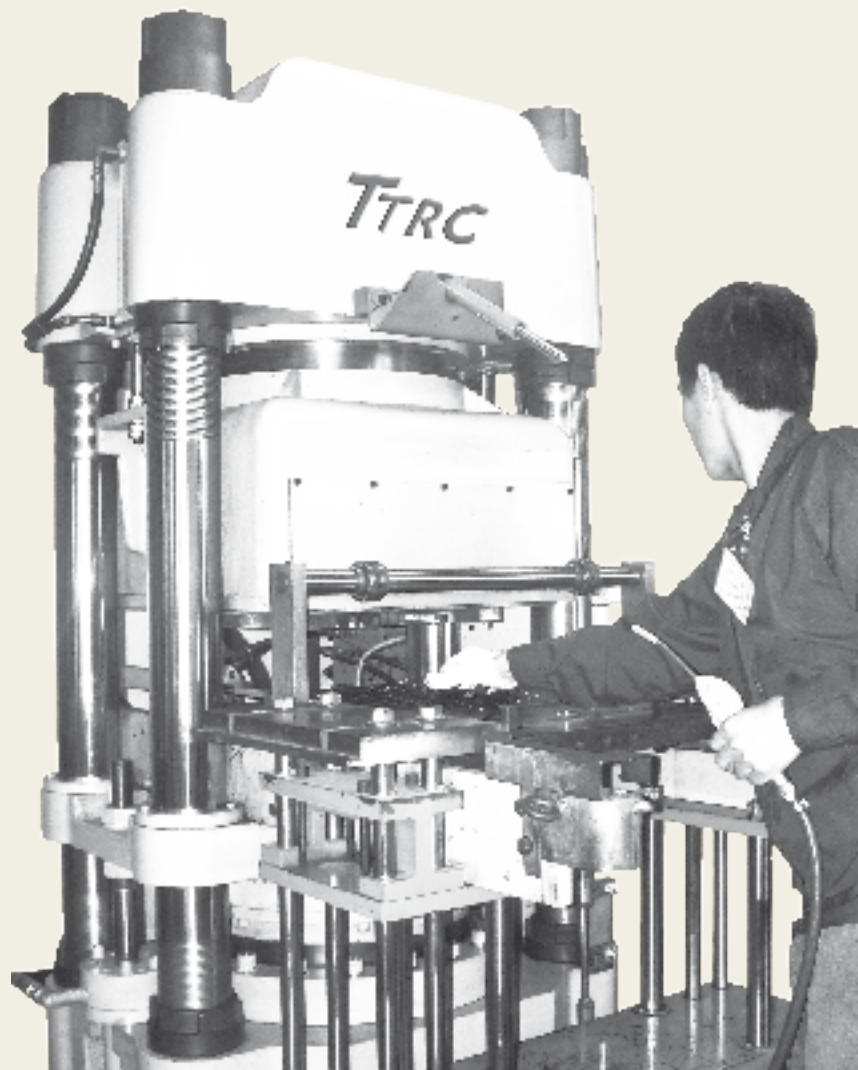

## c) Deflashing process

### ✓ Cryogenic deflashing

The parts in the form of either clusters or sheets, are placed in a rotating sieve, and are sprayed with polymer balls or pellets.

The sieve rotates and the temperature is lowered to  $-50^{\circ}\text{C}$  or  $-70^{\circ}\text{C}$  depending on the material. The balls and pellets are therefore projected on the parts and break up the sheets or clusters. Thus the parts are separated from the flashes.

A polishing tribofinition is usually done to complete cryogenic deflashing.

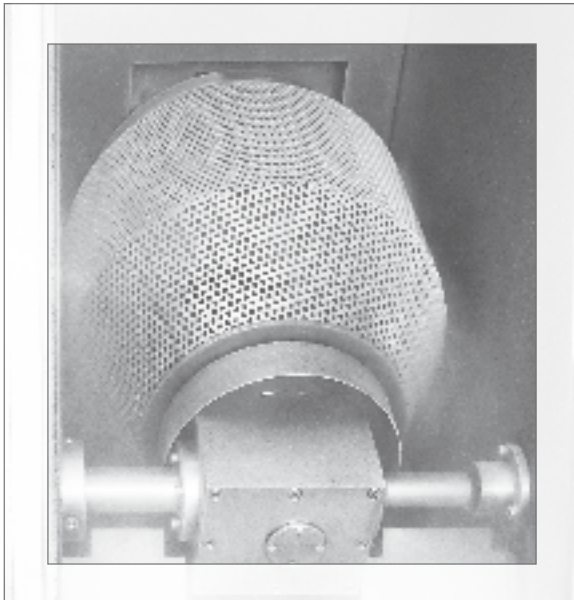

View of cryogenic sieve

### ✓ Manual deflashing

To perform a manual deflashing, a properly adapted tool must be used. During the manufacture of the mould, the "rubber cutting lozenges" are placed around the cavities (see box on page 7). During the deflashing process, the operator pulls on the "rubber cutting lozenges". The forces are transmitted, due to the lozenge profile, on a fragility line, so that part can be torn off from the sheet.

### ✓ Automatic deflashing

In some cases, Techné does an automatic deflashing by cutting, called "trimming".

This especially applies on circumferential parts. To do so, the part is rotated, and a knife comes and cuts of the excess material. A sharp angle is obtained. The part is free from any residual burrs. This is the method used in the manufacture of oil seals. See Techné catalogue, "Rotary seals".

Trimming of oil seal



## d) Cutting process

To manufacture gaskets (flat seals), Techné and its division, Chromex, use an automatic process to cut rubber sheets.

The gaskets (flat seals) are widely used for static sealing. Two different processes exist : with a cutting blade or with a punch press.

### ✓ Blade cutting

#### PREPARATION

The material is placed on the cutting table and is kept in place thanks to a vacuum system. The material comes either in rolls or in sheets. The maximum thickness is 15mm. The cutting table's sizes are 1500 x 3000mm.

#### CUTTING

Depending on the machine's program or the CAD drawing (\*.DXF), the cutting head supporting the blade, moves over the table and cuts the rubber. To optimise the scrap ratio, optical material localisation software is used. This type of cutting is suitable for seals as unique parts, or in small and medium series, with no additional tool cost.

#### TOLERANCES

The general cutting tolerances are of  $\pm 0.2\text{mm}$

### ✓ Press cutting

#### PREPARATION

The material comes either in rolls or in sheets and is placed on the cutting table.

#### CUTTING

The press is equipped with a cutting tool made specifically according to the wished 2D profile. The piston moves down and the tool separates the parts from the rubber sheet. This process is suitable for medium and large series.



Press cutting

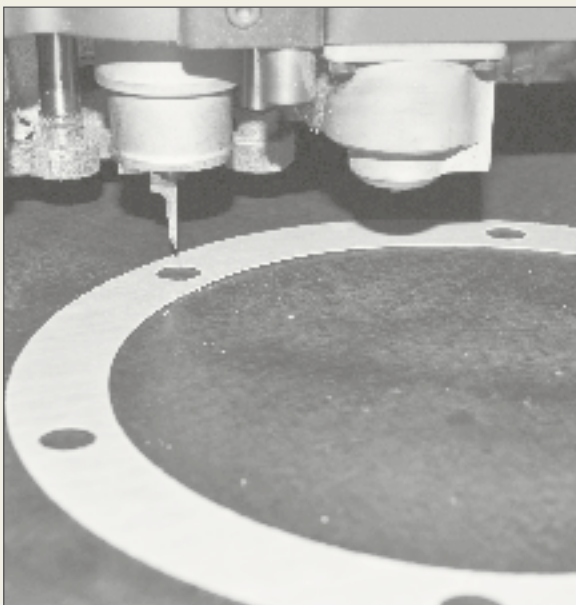

Blade Cutting

## e) Machining process

### ✓ Turning

#### PREPARATION

The raw material is stored in the form of extrusion rods in an automatic air conditioned storage tower. The rods are vulcanized to a hardness of  $83 \pm 5$  IRHD.

Techné has a large number of rods of different diameters available on stock, in order to meet short delivery time expectations. The use of a rod nearest to the dimensions of the finished part helps to optimize production costs and to reduce material waste, and therefore the environmental impact.

#### MACHINING

The rod is placed in the chuck of the lathe spindle, and tools specific to rubber machining, cut out the requested shape.

This process is dedicated to circumferential parts. It is used to manufacture small series, or spare parts based on a model, as well as technical developments.

The machining of elastomers provides a flexible and quick option for the production of prototypes. For more information, see Techné catalogue, "Machined parts".

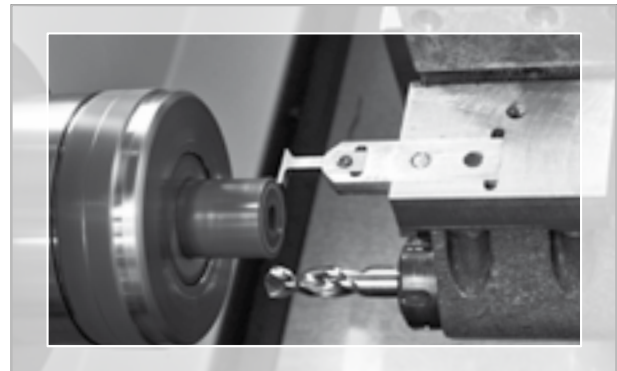

Machining of a rod

#### TOLERANCES

Dimensions	Elastomers & Polyurethane (AU)	Polymers
0 - 3	$\pm 0.10$	$\pm 0.10$
3 - 6	$\pm 0.15$	$\pm 0.10$
6 - 30	$\pm 0.25$	$\pm 0.2$
30 - 120	$\pm 0.3$	$\pm 0.3$
120 - 400	$\pm 0.5$	$\pm 0.5$
120 - 400	$\pm 0.8$	$\pm 0.8$

Techné CNC lathe



f) Comparison of methods<sup>1</sup>

	Injection	Compression	Compression transfer	Cutting	Machining
Tolerances Small dimensions	★★	★★★	★★★	★	★★
Tolerances Large sizes	★★	★★	★★	★★★	★★
Minimum wall thickness	0.5	0.5	0.5	0.5	0.3
Hardness range (IRHD)	30 - 90	30 - 90	30 - 90	20 - 90	83 - 90
3D shapes	★★	★★★	★★	-	★★
Small series	★	★	★	★★★	★★★
Medium series	★	★★	★★	★★★	★★★
Mass	★★	★★★	★★★	★★	★★
Very large series	★★★	★★★	★★★	★	★

Indicative data

<sup>1</sup>Only includes the manufacture of elastomer parts.

## 2. QUALITY MONITORING

### a) Dimensional inspection

In order to guaranty the quality of its parts, Techné has established procedures adapted to meet customer's requirements and specific elastomer characteristics.

#### ✓ Prototypes inspection

At Techné, rubber parts inspection is done with the appropriate tools.

##### NON-CONTACT OPTICAL MEASUREMENT

Rubber parts are soft and deformable. Therefore dimensional measurements are done with a programmable three-dimensional optical tool. It offers an accuracy of 1 to 2.5 microns depending on the measured length. The program allows to repeat measurements following a fixed protocol. This tool can also be equipped with a 3D contact probe for parts with rigid case (metal, plastic, graphite, etc.) bonded or over moulded.

##### CUSTOMER MOUNTING

A mounting test can be done by Techné if the final assembly is provided. And in some cases a sealing test can be done. A measurement of the seal once mounted in the assembly can also be done. For example: box seals.

#### ✓ Mass production inspection

To ensure measurement repeatability on prototype parts and serial parts, the same inspection tools are used:

- Non-contact optical dimensional measurement
- Hardness inspection
- Material inspection

These inspections are done on 5 samples from each manufactured batch. Other inspections can be done. Such as capability controls, or 100% inspections on critical dimensions.

For more information see page 16.

#### ✓ Specific scanning inspection

Techné is equipped with a 2 dimensional optic scanner which enables our inspection department to provide high definition comparisons between the finished parts and the theoretical profile (drawing).

This scanning makes it possible to inspect the shape of part instead of only a few dimensions. This inspection method is more appropriate to deformable parts.

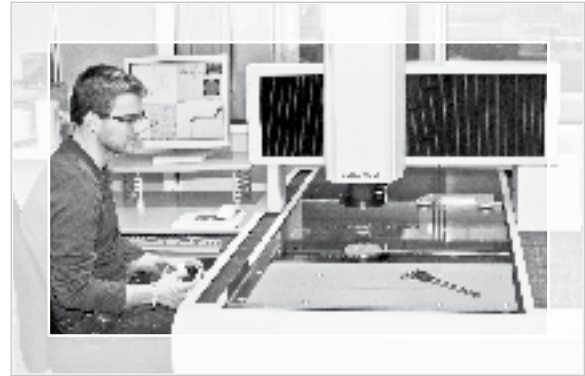

3D optical machine

##### HARDNESS TESTER

At Techné, hardness is measured in IRHD (micro-hardness) on finished parts according to the ISO 48 by taking the median value of three successive measurements. However, on reference plates and buttons, hardness is measured in Shore A. See page 27.



Non-contact optical dimensional measurement on box seal



Superposition by scanning



## b) Inspection

### ✓ Visual Inspection

Techné does a visual inspection according to AQL 1.0 level II as standard. This method, widely used in the industry, is applied to a sample of parts selected at random once they are manufactured and packed.

AQL TABLES

Batch size	Code letters corresponding to the batch size						
	General inspection levels			Specific inspection levels			
	I	II	III	S1	S2	S3	S4
2-8	A	A	B	A	A	A	A
9 - 15	A	B	C	A	A	A	A
16 - 25	B	C	D	A	A	B	B
26 - 50	C	D	E	A	B	B	C
51 - 90	C	E	F	B	B	C	C
91 - 150	D	F	G	B	B	C	D
151 - 280	E	G	H	B	C	D	E
281 - 500	F	H	J	B	C	D	E
501 - 1200	G	J	K	C	C	E	F
1201 - 3200	H	K	L	C	D	E	G
3201 - 10000	J	L	M	C	D	F	G
10001 - 35000	K	M	N	C	D	F	H
35001 - 150000	L	N	P	D	E	G	J
150001 - 500000	M	P	Q	D	E	G	J
> 500000	N	Q	R	D	E	H	K

Sampling plans for a normal inspection

Code Letter	Nb. Sample	Acceptable Quality Level (AQL)										
		0.065 Ac Re	0.1 Ac Re	0.15 Ac Re	0.25 Ac Re	0.4 Ac Re	0.65 Ac Re	1.0 Ac Re	1.5 Ac Re	2.5 Ac Re	4 Ac Re	6.5 Ac Re
A	2	↓	↓	↓	↓	↓	↓	↓	↓	↓	↓	0 1
B	3	↓	↓	↓	↓	↓	↓	↓	↓	↓	↓	0 1
C	5	↓	↓	↓	↓	↓	↓	↓	↓	↓	↓	0 1
D	8	↓	↓	↓	↓	↓	↓	↓	↓	↓	↓	0 1
E	13	↓	↓	↓	↓	↓	↓	↓	↓	↓	↓	0 1
F	20	↓	↓	↓	↓	↓	↓	↓	↓	↓	↓	0 1
G	32	↓	↓	↓	↓	↓	↓	↓	↓	↓	↓	0 1
H	50	↓	↓	↓	↓	↓	↓	↓	↓	↓	↓	0 1
J	80	↓	↓	↓	↓	↓	↓	↓	↓	↓	↓	0 1
K	125	↓	↓	↓	↓	↓	↓	↓	↓	↓	↓	0 1
L	200	↓	↓	↓	↓	↓	↓	↓	↓	↓	↓	0 1
M	315	↓	↓	↓	↓	↓	↓	↓	↓	↓	↓	0 1
N	500	↓	↓	↓	↓	↓	↓	↓	↓	↓	↓	0 1
P	800	↓	↓	↓	↓	↓	↓	↓	↓	↓	↓	0 1
Q	1250	↓	↓	↓	↓	↓	↓	↓	↓	↓	↓	0 1
R	2000	↓	↓	↓	↓	↓	↓	↓	↓	↓	↓	0 1

Use first sampling plan above arrow  
 Use first sampling plan below arrow  
 Ac: Acceptance number  
 Re: Rejection number

## ✓ 100% visual inspection

On demand, Techné offers a 100% visual inspection of the seal's dimensions (L, l, h, diameters, radii...) and on potential defects of the seal's surface (lack of material, remaining burs, geometrical defects, flatness...)

## ✓ Inspection by automatic sorting machine

On demand, Techné also offers a 100% automatic optical control and sorting of its rubber parts. This control includes circular but also complex parts. Customers from the automotive world and other markets with low ppm-level commitments mostly use this kind of control.

Control possibility on Techné devices for:

- ØD mini 5mm,
- ØD max 55 mm
- Height mini 1 mm
- Height max 8 mm

## c) Packaging

### ✓ Standard

Techné parts are packed in opaque antiUV and antistatic bags as standard. The parts are therefore protected from premature aging. A quantity inspection is made during packaging (total weight divided by the weight of one part). Techné uses standardised packaging:

- GALIA standard boxes
- Box weight < 25kg
- Standard pallets (eg : dimensions 600x800, 800x1200, etc.) with easy operable heights and compatible with standard inventory racks.

### ✓ Specific

On demand, and to avoid parts deformation, Techné offers specific packages. Examples:

- Air filled PE bags
- Cardboard slip-sheets
- PVC or PET gauges made acc. Seal's shape
- Automatic bagging system linked with a sorting device
- Aeronautical applications : individual packaging with labels acc. aeronautical standards (with Order Nr., NF L certificate Nr., customer & Créat Nr., batch Nr., curing date and expiry date.



### ✓ Clean room

For applications requiring very clean parts:

- Medical applications
- Very small diameter valves
- Automotive applications
- Pneumatic applications, etc.

In these cases Techné uses a double bagging.

#### WASHING

Techné offers adapted washings according to its customers' requirements, and especially for electronic, food, pneumatic and pharmaceutical applications. Please see T-surf treatments page 51.

#### CLEANLINESS

To meet its customers' specifications, Techné has invested in specific devices, able to analyse its parts' cleanliness. Techné also offers tests to determine the level of particles contamination on rubber parts. This equipment consists of an extraction device for pollution, a precision scale and an automatic counting station. This allows Techné to offer a complete analysis of the parts' cleanliness. These devices are located in a controlled environment (grey room).

Processes

6

## Development

18

Materials

26

Coatings

50

### Development

- 18 Feasibility study
- 19 Techné design
- 20 Prototype
- 21 Quality monitoring

### Techné's skills

- 22 Business sectors

# 1. DEVELOPMENT

## a) Feasibility study

18

When the development is done by the customer, Techné engineers provide advice in order to optimise the profile depending on chosen manufacturing process. Parting lines, materials, tolerances are reviewed with the customer.

### ✓ Advantages

#### PARTING LINE POSITIONING

Thanks to its experience and process knowledge, Techné will position the parting lines in areas with little or no impact for the sealing function in order to guarantee a quality sealing. Techné production drawing is then submitted to customer approval.

#### TOLERANCING

Rubber parts are toleranced according to the chosen process, and the appropriate international standards. Warning: Elastomers are flexible and deformable; therefore standards and regulations defined for plastic and metal parts may under no circumstances apply to them.

Centering: when creating the drawing, it is highly recommended to use centered tolerances. Due to the moulding process (we do not start from a raw part), the mould production, and the material shrinkage, there will not be any materials savings if tolerances are not centered.

#### FILES SHARE

For the production of the moulding tools Techné's technical department prefers to work with 3D CAD models with centered dimensions : \*.stp files.



Progress of the design study in Techné with the customer

#### MATERIAL KNOWLEDGE

There are so many different elastomers types, crosslinking agents, hardnesses, compression set, etc. Each compound has its own characteristics. Depending on the application, environment, and the required mechanical properties, Techné will select the appropriate compound for your application. For an overview of the different material characteristics, see page 26.

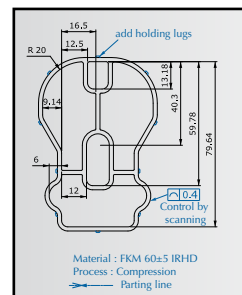
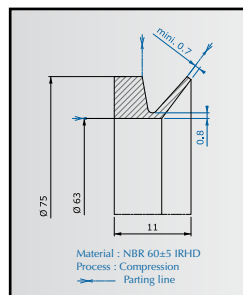
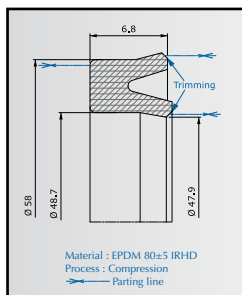

Examples of customer drawings modified by Techné (blue color)

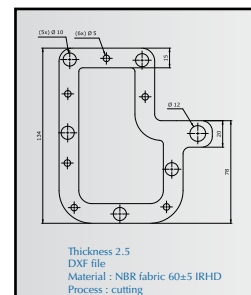

## b) Techné design

### ✓ From the customer seal specification sheet

When the customer has a clear idea to what profile he needs, Techné will then provide its expertise.

- A complete revision of the required specifications (environment, dynamic/static, temperature, pressure, standards and certifications, etc...).
- Optimisation of the seal's profile.

#### EXAMPLE : ANTI-POLLUTION SEALS FOR AGRICULTURAL DEVICES

What does the customer want?

- Seal approval after tests on test bench
- Use parameters (pressure, speed, temperature)
- Characterisation of the results: regular sealing checks at chosen frequencies.

What does Techné do?

- Chooses a material with an optimised abrasion resistance
- Recommends the appropriate housing surface roughness
- Offers a bench test approved seal.

In order to manufacture the most efficient and worthwhile design, it is important that Techné technical department provides its expertise with the design as soon as possible. For any demand, please use the design sheet, page 138.



### ✓ From a performance specification sheet

- Study of the customers' specification sheet
- Proposal of one or more sealing solutions
- Prototype and production quotation.

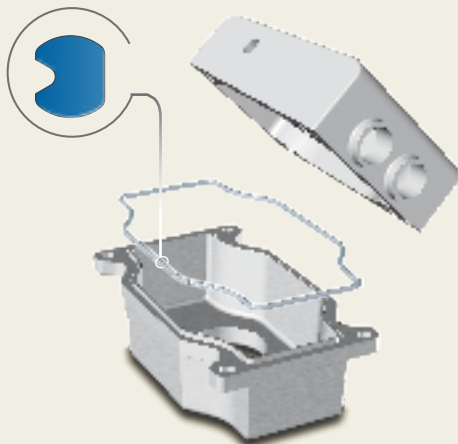

#### EXAMPLE : BOX SEAL FOR ELECTRONIC CARD.

What does the customer want?

- Static sealing from the outside to the inside
- Wide temperature range
- Resistant to high pressure washing
- Maintain the seal in its groove
- Suitable for automatic mounting.

What does Techné do?

- Designs a suitable profile
- Selects a material compatible with the environment
- Adds a T-Lub coating treatment (see page 53) to make automatic seal mounting easier.

## c) Prototype

The prototype aims to determine sealing, to save time on the design and to avoid any modification on serial production moulding tool.

Techné offers various prototype manufacturing processes.

20

### ✓ Processes

#### MACHINED PROTOTYPES

To be machined, a prototype must meet the following criteria :

- High hardness 83 IRHD for rubber. 90 to 95 IRHD for thermoplastics
- Revolution parts (milling, drilling, tapping can be done)
- Minimum radius of 0.4mm.

For more information on this process, see page 12.

#### CUT OUT PROTOTYPES

In its cutting division (Chromex), Techné manufactures sealing parts by automatic cutting process. This process, which is well suitable for gaskets, allows most 2D profiles from thickness 1 to 15mm depending on the material. For more information on this process see page 11.

#### STEREOLITHOGRAPHY

Techné offers prototypes using a silicone mould obtained by stereolithography. The finished parts are made in PU resin or silicone material. These materials have similar mechanical properties to elastomers. This process allows manufacturing of complex 3D and 2D profiles.

Prototype mold, 3 plates, 1 cavity, of a membrane



Membrane

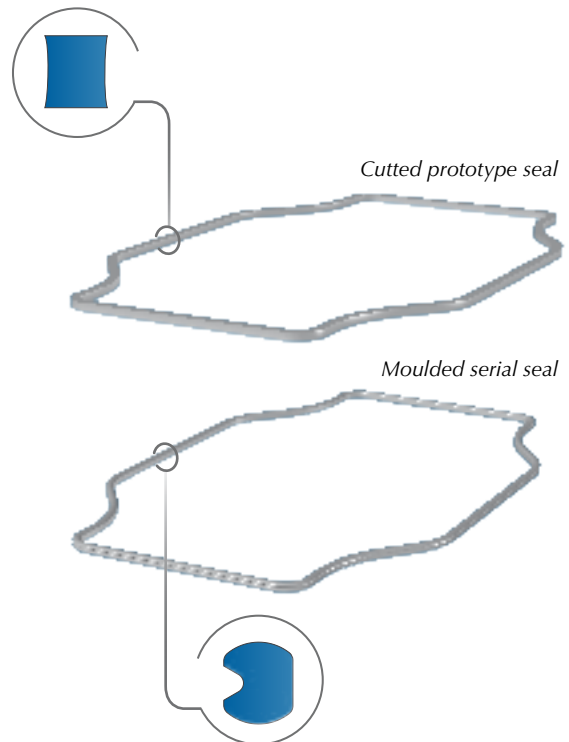

#### PROTOTYPE TOOL

The prototype tool is made for compression process and has a reduced number of cavities. It offers the following advantages:

- Better representation of mass production parts
- Use of same compounds as the one for mass production
- Approval of cross linking parameters
- Economical, flexible and faster realisation.

#### CRÉAT PROTOTYPES (MADE IN FRANCE)

Créat (new member of Techné Group) produces rubber-moulded parts made by injection and compression moulding. Créat is mostly specialised in seals for aeronautical and railway applications. Créat produces prototypes, parts in small and medium size quantities within a short delivery time (2 to 4 weeks). Créat has an integrated tooling shop for O-Rings up to 200 mm OD and 12 mm cross section.

Thanks to its reactivity and flexibility, Créat offers parts made of aeronautical approved compounds but also many standard compounds (FKM, FFKM, EPDM, HNBR ...).

Cross-section of cavity

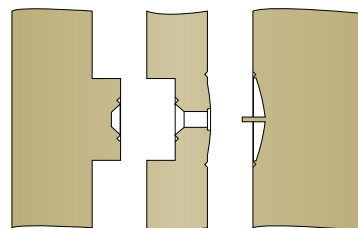

## d) Quality monitoring

### ✓ Documents

#### CERTIFICATES

On request Techné can provide the following certificates together with the delivery of the parts (NF EN-10204):

Certificate	French	English
2.1	Déclaration de conformité à la commande sans mention de résultats d'essai	Declaration of compliance with the order without mentioning inspection results
2.2	Déclaration de conformité à la commande avec indication de résultats de contrôle non spécifiques	Declaration of compliance with the order mentioning inspection results on incoming batch
3.1	Déclaration de conformité à la commande avec indication de résultats de contrôle spécifiques	Declaration of compliance with the order mentioning inspection results on each delivery

21

#### INITIAL SAMPLES & PRODUCTION PART APPROVAL PROCESS (PPAP)

The initial samples are the first parts coming out from the mass production tool. They are used for the approval/qualification of the tool and process. These initial samples can be delivered with a PPAP.

Depending on the criticality of the part, a PPAP requirement level (1, 2 or 3) is agreed together with the customer. Techné provides on request, a folder that can contain the following documents:

- Cover page according to VDA
- Dimensional measurements
- Material checking
- Drawing
- Process FMEA
- Production flowchart
- Control plan
- Process capabilities
- List of inspection tools

- R&R (repeatability & reproducibility)
- Safety Data sheet
- Material data sheet
- IMDS declaration (International Material Data System)
- TPD sheet (Transport Packaging Description)
- Certificate (see above)
- Security plan
- Tool picture.

For more information or request, see page 138.

## 2. TECHNÉ'S SKILLS

### a) Business sectors

22

Techné is involved in various industry sectors. They can be listed as follow :

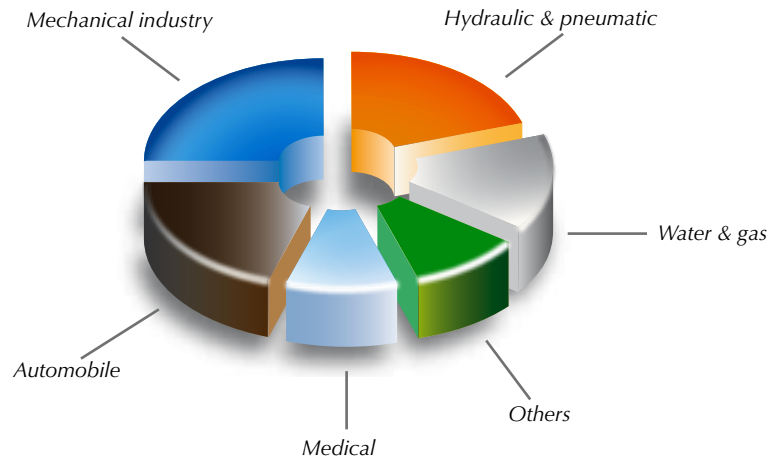

#### ✓ Mechanical engineering industry

This sector is an important part of Techné activity. Thanks to its knowhow and experience, Techné offers innovative solutions supported by a wide range of standard parts as well as drawing parts.

#### EXAMPLES

- Sealing solutions with an extremely low friction coefficient, especially in the sport field applications
- Silent sealing for home appliances applications
- Complete sealing set for safety valves
- Self lubricating compounds to reduce assembly efforts and save energy.





## ✓ Automotive industry

For all automotive applications, Techné has a wide range of high quality compounds that meet the specifications of the major original equipment manufacturers (OEM).

With an ISO TS 16949 certified factory, high performance monitoring tools, and an experienced technical team, Techné has everything to support customer product developments.

### EXAMPLES

Techné designs seals in the key areas of car and lorry driving.

- Steering systems
- Gear boxes
- Lights
- Air conditioning, interior comfort, etc.



23

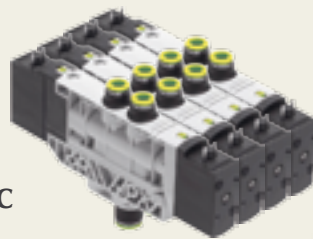

## ✓ Hydraulic & Pneumatic

When the transfer of power via fluids is involved, hydraulics seals are often subject to strong or very strong pressures (up to 1000 bars and sometimes more). Techné offers a wide range of mixtures and profiles to meet customer requirements.

For all pneumatic applications which combine high linear speed, miniaturisation, high performance sealing or intense use, Techné provides high performance seals, with innovative designs that will meet your demands.

### HYDRAULIC SEALING EXAMPLES

- PU THP lip seals for high temperature applications
- Multi-material composite seals
- Metal-plastic seals for high and very high pressure resistance.

### PNEUMATIC SEALING EXAMPLES

- Box seals for differential distributor with fixing joggle
- ZOP profile seals for high speed application with little available space
- Precision lip seals guaranteed without burr.



## ✓ Water and gas

Food, gas and water metering have common characteristics. They all need dimensional accuracy, reliability, service life and respect of national and international regulations.

Techné offers seals to meet these requirements with a wide range of homologations from different countries worldwide. (See page 44).

### EXAMPLES

- Complete sets of seals for gas safety valves
- Valve seals in NBR material and homologation EN549 and EN 682
- Many moulded seals in EPDM 334701 material which combines key European drinking water homologations (See “Materials” page 26).



**USP** U.S. PHARMACOPEIA  
The Standard of Quality™

## ✓ Medical & cosmetics industry

For applications requiring chemically inert materials, respect of the human body as well as national and international regulations, Techné offers compounds which are certified to the standard regulation in this application field: USP class VI approval.

### EXAMPLES

- Syringe seals
- Seals for medical gases
- Moulded silicone parts
- Cosmetic approved moulded parts (high chemical neutrality).

6

Processes

18

Development

26

# Materials

50

Coatings

## 1. Properties of an elastomer

- 26 Basic principles
- 27 Hardness
- 28 Specific gravity
- 29 Temperature resistance
- 30 Compression set
- 30 Tear strength
- 31 Tensile strength
- 32 Ageing resistance

## 2. General rubber description

- 35 NBR (nitrile)
- 35 HNBR (hydrogenated nitrile)
- 36 EPDM (Ethylene propylene diene monomer)
- 37 FKM (fluoro elastomer)
- 38 FFKM (perfluoro elastomer)
- 38 VMQ (Silicone)
- 38 FVMQ (Fluorosilicone)
- 39 CR (chloroprene)
- 39 IIR (butyl elastomer)

## 3. Plastic in the sealing world

- 40 PTFE (Polytetrafluoroethylene)
- 40 TPU (Thermoplastic polyurethane)

## 4. Certifications

- 41 Main standard organisations
- 42 Main certifications
- 44 Techné certifications
- 45 Techné certifications for aeronautical applications

# 1. PROPERTIES OF AN ELASTOMER

## a) Basic principles

Techné uses elastomers and thermoplastics for manufacturing seals and technical parts. They are characterised by specific properties that determine their sealing capabilities and life time.

### DESCRIPTION OF ELASTOMERS ACCORDING TO ISO 1629

Elastomer		
Chemical designation	Abbreviation	Trade names
Nitrile butadiene rubber	NBR	Beon, Butacril, Butakon, Europrene N, Perbunan
Hydrogenated butadiene nitrile rubber	HNBR	Therban
Acrylonitrile Butadiene Carboxy Monomer	XNBR	
Ethylene Propylene Diene Monomer	EPDM	Buna AP, Dutral, Keltan, Polysar EPDM, Vistalon
Fluoro silicone	VMQ	Rhodorsil, Silastic, Siloprene, Silicone
Fluorocarbon rubber	FKM	Fluorel, Tecnoflon, Viton
Perfluorocarbon rubber	FFKM	Chemraz, Kalrez, Simriz
Polychloroprene	CR	Baypren, Butaclor, Neoprene
Polyacrylate rubber	ACM	Cyanacryl, Europrene AR, Nipol AR, Noxtite PA
Ethylene-acrylate rubber	AEM	Vamac
Thermoplastics		
Polytetrafluoroethylene	PTFE	Algoflon, fluon, Teflon
Perfluoroalkxy	PFA	
Polypropylene	PP	Hostalen PP, Novolen
Polyamide	PA	Durethan, Dymetrol, Nylon, Rilsan, Ultramid
Polyoxymethylene	POM	Delrin
Polyether ether ketone	PEEK	Peek Victrex
Polyvinyl chloride	PVC	Breon, Hostalit, Plaskon
Elastomer thermoplastics		
Polyurethane (AU or EU)	PUR (PU)	Adipren, Desmopan, Elastothane, Vulkollan

Techné mainly uses thermoplastics for its machining workshop. For more information on those materials, see Machined parts catalogue.

The properties of the elastomers are described there-after.

## b) Hardness

The hardness measures the resistance of a sample to permanent plastic deformation due to a constant compression load from a sharp object.

### ✓ Measurement unit

The hardness measurement unit of rubber called IRHD (International Rubber Hardness Degree), is defined by the ISO 48. IRHD is a synonym for DIDC (Degré International de Dureté des Caoutchoucs in French)

**Techné measures its parts in IRHD.**

### GENERAL TOLERANCES

Whatever the chosen unit is, the tolerances are typically within  $\pm 5$  points to take into account the variability of the compound preparation process and of the production process, but also the potential inaccuracy of the measurement method.

### THE ADVANTAGES OF AN IRHD MEASUREMENT

The measurement on finished part is more accurate, and closer to the customer's need and his application.

Moreover the IRHD measurement guarantees the curing of the finished part, whereas the measurements done on a hardness button won't: same compound but different curing parameters (See on the right).

Finally the production of different parts with the same compound (or mixture) often requires different curing parameters. (For example an Oring with cross section  $\varnothing 5.33$  will require a longer curing time than an Oring with cross section  $\varnothing 1.78$ ). It is therefore important to check the hardness on the finished part.

### DIFFERENCES IN RESULTS

When hardness measurements are done according to the ISO 48 and ASTM D2240 (which is usually only possible on hardness buttons, not on finished parts), results with IRHD scale and the Shore A scale are fairly similar, especially for low hardness. However, they are not strictly the same. Indeed, depending on the shape of the part, we can regularly notice a 5 points hardness difference between Shore A and IRHD measurement done on the part. This difference can even be extended to 10 points difference in extreme cases. In general, IRHD results are inferior to Shore A results. That is why it is common to use "75 Shore A compounds" to obtain "70 IRHD part". For example, parts moulded with a "70 Shore A compound" can give finished parts with a hardness from 62 to 65 IRHD, and therefore out of the  $70 \pm 5$  IRHD tolerance.



IRHD hardness tester

## IRHD or SHORE A ?

### IRHD

ISO 48 defines all the different IRHD hardness measurement methods. Techné uses the M method (which stands for Micro-test) and the CM method (with stands for Micro-test on curved surfaces). These methods allow the following measurements :

- Measurements ranging from 30 IRHD to 95 IRHD
- Measurement on curved surfaces if the curvature radius is  $> 0.8$  mm
- Measurement on parts with at least 2mm thickness. Some parts less thick can be accepted.
- Measurement located 2mm from all edges if possible, otherwise as far away as possible from the edges
- Measurement for 30 seconds.

### SHORE A

The Shore A, defined by the US standard ASTM D2240, is also used to qualify compounds. This standard requires measurement method :

- Measurement on parts with 6mm thickness
- Measurement located 12mm away from part edges
- Measurement on a flat surface, not rough
- Measurement on a sample with two parallel sides
- Measurement for 3 seconds

It is therefore impossible, in most cases, to measure a part in Shore A according to the ISO 48 standard.

## IRHD SCALE

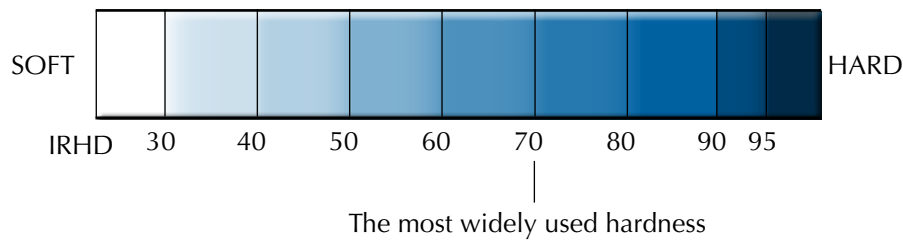

28

## c) Specific gravity

The density or specific gravity is the ratio in between the weight of a volume of the measured material and the weight of an equal volume of a reference substance, usually pure water.

Techné uses a densitometer to check the specific gravity of its materials.

## ✓ Specific gravity calculation

If one is not equipped with a densitometer, it is however possible to measure the volume of a part by immersing it in water and measuring the weight of the volume of water displaced (Archimedes' principle).



Densitometer

$$d = \frac{P}{V}$$

$d$  : Density (or volumic mass, the density of water is equal to 1)  
 $P$  : Weight of sample  
 $V$  : Volume of sample

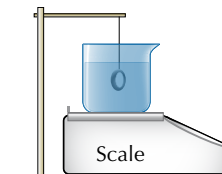

## MOST WIDELY USED DENSITIES

Material	Density	Identification
NBR	1,15 - 1,32	Cracks appear after ozone or UV exposure.
EPDM	1,05 - 1,20	Material swells in contact with oil (1/2 h)
FKM	1,80 - 2,20	Material does not burn
CR	1,35 - 1,45	Material does not burn, self-extinguishing
Silicone	1,00 - 1,70	Material grips

## ✓ Identification

With a simple density measurement, it is sometimes difficult to identify a material. Indeed, some rubber densities are similar to others. By knowing how and where the seals were used – temperature, pressure, environment (water, oils, air etc...) – it is possible to identify the material that was used.

## d) Temperature resistance

Elastomers are characterised by their temperature use range. Some may be available with an extended temperature range. For example NBR is usually down to -25°C, however Techné can provide low-temperature NBR that will work in temperature as low as -40°C or even -50°C.

COMPARISON TABLE

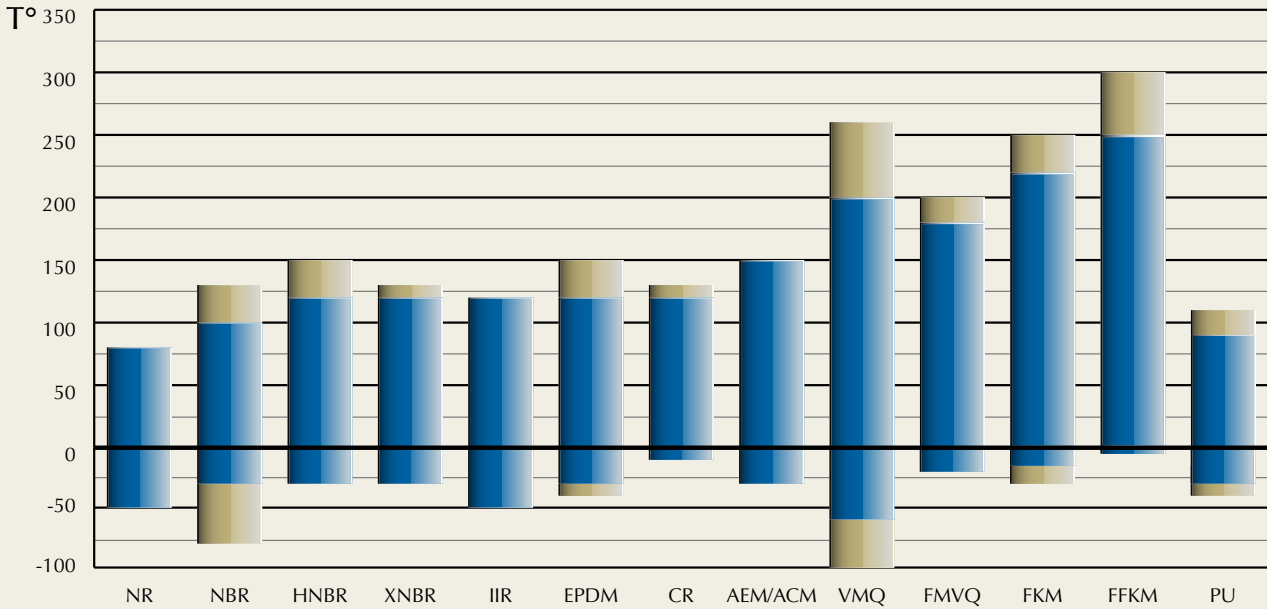

*This information is on a guidance basis only. Do not tend simultaneously to the limit of all the properties of the material. For very high or very low working temperatures, consult our technical department.*

## e) Compression set

### ✓ Principle

When compressed, rubber parts show a plastic and an elastic deformation range. To determine the elastic recovery of the rubber, Techné measures the compression set.

This is also used to evaluate the quality of the vulcanisation.

$$\text{DRC (\%)} = \frac{H_0 - H_2}{H_0 - H_1}$$

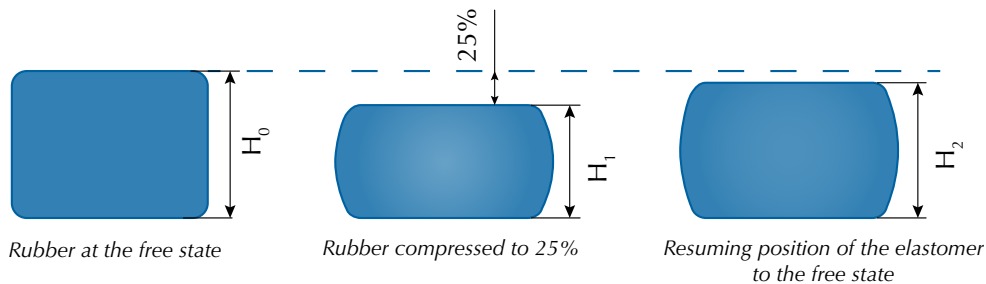

The compression set test is performed according to the ASTM D395 B. Principle: the specimen is compressed by 25% in a special mounting for a set time and at the maximum working temperature. The specimen is therefore aged for 24, 48 hours or more.

The lower the result, the better the compression set is:

- the material has a good shape memory if the compression set is close to 0%
- the material has a bad shape memory if the compression set is close to 100%.

### ✓ Compression set on material datasheet

The compression set shown on the material datasheets were measured on slabs with 6mm thickness. Tests performed on O-rings are not as good because they are not as thick and the shape is different. The compression sets on shaped parts are not defined in any standard. It is possible, however, to test these parts but it will be for information purpose only.

It is usually considered that the compression set obtain on the finished part is good as long as it is no more than 2 times higher than the results on test slabs.

## f) Tear strength

Tear strength according to ASTM D624/B determines the sensitivity of elastomers to stress concentrations due to cuts and tears (measured in N/mm). This feature has no link with tensile strength or elongation at break. Tear strength is often useful to characterise materials used for membranes or diaphragms.



## g) Tensile strength

### ✓ Principle

The aim is to measure the force needed to tear a standard slab (according to ASTM D412/C dumb-bell shaped slabs) during a regular traction. The tensile strength (called "T") is measured in MPa whereas the elongation (called "A") is measured in % of the initial size of the test slab.

For tests on O-rings (ID mini 60 mm) or slabs, Techné uses a dynamometer which is equipped with motorised wheels in order to distribute the constraint.

The elongation at break measured on O-rings will not be as good as the elongation measured on test slab (50% of what is indicated on the material data sheet).

Material hardness has a big influence on elongation at break and tensile strength.

- For a low hardness : A high, T low
- For a high hardness : A low, T high.

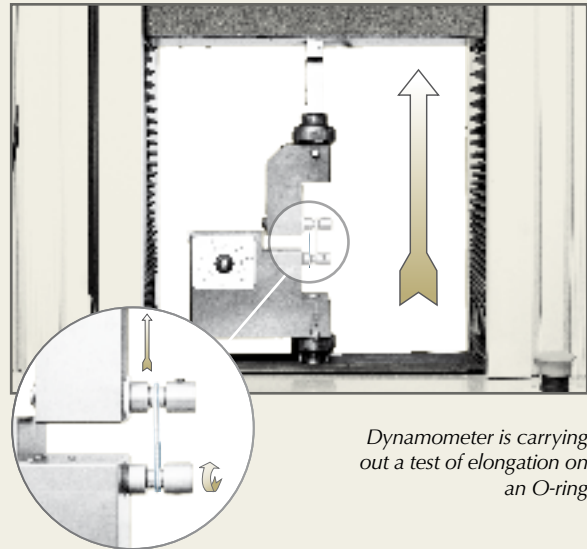

*Dynamometer is carrying out a test of elongation on an O-ring*

### ✓ Automatic assembly

When seals are automatically assembled, customer requirements concerning elongation at break must be taken into account. Techné provides specific compounds on which a surface treatment can be applied in order to make assembly easier. (see "T-lub" page 53).



*Vibration bowl feeder*

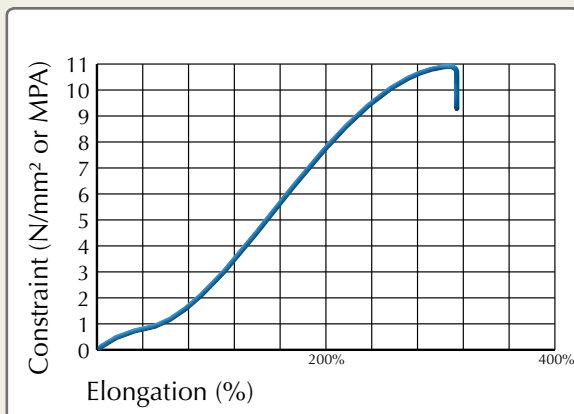

*Example of a tensile curve on a O-ring*

## h) Ageing resistance

To choose the appropriate compound, the fluids in contact with the seals must be analysed. It is therefore important to specify the environment in which the rubber will be working in.

A material that is not appropriated will have direct influence on the efficiency of the sealing: hardness modifications, elongation reduction, loss of tensile strength, swelling or retraction of the rubber part.

According to the ASTM D471 standard, test slabs are placed in a fluid for a given amount of time (24, 48, 72.... hours) at a given temperature. After ageing we measure variations of:

- Hardness
- Volume
- Tensile strength
- Elongation
- Weight.

## ✓ Fluid resistance

In order to avoid testing a lot of different fluids, reference fluids have been created:

- Air, Water, steam
- ASTM 1, 2, 3 oils
- Fuel A, B, C etc...

The table below gives the indicative resistance to these fluids. For specific fluids (alcohols, chemicals, solvents...), refer to the chemical compatibility tables at the end of this chapter (see page 130). These chemicals compatibility indicators are given on guidance bases only. Techné recommends to all its customers to make trials with the chosen material and the fluid used.

RESISTANCE TABLE OF USUAL FLUIDS

Fluid	T°C	EPDM	NBR	AEM	VMQ	FKM
Mineral oil	100°C	4	1	1	3	1
PAO oil (poly-alpha-oléfines)	100°C	4	1	1	3	1
PAG oil	100°C	2	2/3	1/2	3	1
Silicone oil	100°C	2	1	1	4	1
Vegetable oil, animal fats	80 °C	2/3	1	1	2/3	1
Kerosene	20°C	4	1	2	4	1
Acetone	20°C	1	4	4	4	4
Water	20°C	1	1	1	1	1
Water	100°C	1	2	4	1	2/3
Aqueous glycol	100°C	1	1	4	1	2
ATF oil	100°C	4	1	4	3	1
Reference oil ASTM1	100°C	4	1	1	2	1
Reference oil ASTM2	100°C	4	1	1	2	1
Reference oil ASTM3	100°C	4	1	1	3	1
ATE Liquid (Brake Fluid)	100°C	1	4	4	2	4
Fuel A	60°C	4	1	3	4	1
Fuel B	60°C	4	2/3	4	4	1
Fuel C	60°C	4	4	4	4	1

1 : excellent, 2 : good resistance, 3 : average, 4 : to avoid.

## ✓ About hydraulic fluids

The above table gives the elastomer resistance with the most of hydraulic fluids.

Oil - Type	ISO 6743	Designation	Application	NBR	HNBR	FKM	PU	PTFE	EPDM	MVQ	
				Maximum temperature admitted (C°)							
ISO 11158	Mineral oils	<b>HH</b>	Uninhibited pure mineral oils without additives	Only ensure power transmission, not protection nor lubrication. Not used a lot anymore	100	130	150	110	200	/	150
		<b>HL</b>	Mineral oils with enhanced anti-oxidation properties	Excellent performance with water. Used under low pressure systems							
		<b>HM</b>	Same properties as HL oils but with enhanced wear proof properties	Widely used in high pressure systems							
		<b>HV</b>	Same properties as HM oils, but with enhanced temperature viscosities properties	Used in low temperature applications or with big temperature variations. Used in naval and automotive industries. Most widely used oils							
		<b>HG</b>	Same properties as HV oils, but with anti-stick lip properties	Used in systems where sliding and hydraulic parts have a common circuit							
ISO 12922	Hardly inflammable fluids	<b>HFAE</b>	Oil emulsions in water (more than 95% of water)	Used in large hydraulic systems with a high leak risk. Hydraulic presses	60	60	60	40	60	60	60
		<b>HFAS</b>	Aqueous chemical (more than 95%water)								
		<b>HFB</b>	Oil emulsions in water (more than 40% of water)	Rarely used						/	
		<b>HFC</b>	Aqueous polymers solution (polyethylene glycogen or polypropylene) with more than 35% water	Most widely used. Used in industrial systems where maximum temperature does not exceed 60°C with average pressures	60	60	60	/	60	/	60
		<b>HFDR</b>	Synthetic fluids without water, based on phosphoric esters	Used in high temperatures and high pressures systems	/	/	100	/	100	100	100
		<b>HFDU</b>	Synthetic fluids of different composition		100	/	100	/	100	/	100
ISO 15380	Bio-compatible fluids	<b>HETG</b>	"vegetable oils"	Agricultural and forest applications	60	80	80	60	80	/	80
		<b>HEPG</b>	Polyglycols	Water protection applications							
		<b>HEES</b>	Synthetic esters	Construction machinery	100	100	100	100	100		
		<b>HEPR</b>	Polyalphaolefins and hydrocarbon products								

## ✓ Ozone

When talking about ageing, ozone resistance is to be taken into account. Certain materials have an intrinsic resistance to ozone, and others don't (depending on customer requirements, Techné uses anti ozone additives). Ozone resistance tests are defined by the ASTM D1171:

The test parts are stretched and placed in an ozone chamber where following parameters are inspected :

- Temperature
- Hardness
- Ozone concentration.

After testing, the test parts must not show any cracks.

34

## ✓ Storage

### RULES

Storage conditions have a direct influence on the mechanical properties of the part. The ISO 2230 outlines strict storage conditions.

Rubber must be protected from:

- Direct light and UVs
- Ionising radiations
- Ozone (no mercury lamps, avoid combustion gases and proximity with electric motors)
- Fluids and steam
- Squashing.

Storage temperatures must be in-between 15°C and 25°C, in a ventilated area. The seals must not be stretched or mounted when stored.

### SHELF LIFE ACCORDING TO ISO 2230

5 years	7 years	10 years
NR PU (AU/EU)	NBR HNBR ACM AEM CR IIR	EPDM FKM VMQ FVMQ

The storage period can be increased of:

- 2 years for the 5 years group
- 3 years for the 7 years group
- 5 years for the 10 years group.

This extension of shelf life is subject to complete inspection of the part. This testing is done to verify that the parts have kept all their properties.

## 2. GENERAL RUBBER DESCRIPTION

### a) NBR (Nitrile)

#### CHARACTERISTICS

Because of its excellent oil resistance, low price and good mechanical properties, NBR is the most used rubber.

#### USES

- Hydraulics
- Water treatments (EPDM is advised for drinking water applications)
- V-seals
- Gases (with EN 549 certification).

#### DEVELOPMENTS

Techné has a number of specific NBRs:

- With enhanced wear resistance
- Ozone resistant
- Low temperature (-40°C /-50°C).

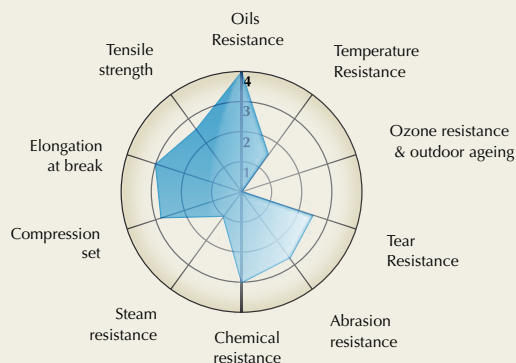

4 : excellent, 3 : good, 2 : average, 1 : bad, 0 : to avoid



### b) HNBR (Hydrogenated nitrile)

#### CHARACTERISTICS

HNBR is used when NBR finds its limitations. HNBR has a wider temperature range, for an equivalent oil resistance. Ozone resistance is also better.

#### USES

- Box seals
- Pneumatic because of better wear resistance
- Biodiesel, LPG.

#### DEVELOPMENTS

Techné has a number of specific HNBRs with an even better wear resistance.

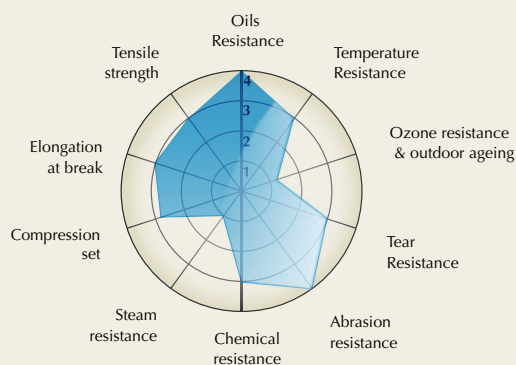

4 : excellent, 3 : good, 2 : average, 1 : bad, 0 : to avoid

## c) EPDM (Ethylene propylene diene monomer)

### CHARACTERISTICS

Thanks to its excellent resistance to outside conditions (UV, ozone resistance, etc), and its excellent compatibility with water and steam, EPDM is the second most used rubber in the sealing world. It is the most certified rubber.

### USES

- Plumbing, domestic or drinking water (see Techné's approvals on page 44)
- Steam resistance
- Chlorinated water, UV, ozone resistance
- Home appliances
- Aseptic seals with FDA, USP VI and 1935-2004 approvals
- Glycol based brake fluids resistance.

EPDM can be stored outdoor or in contact with ozone.

### PEROXIDE OR SULFUR CURED EPDM

The working temperature of your application will help Techné to choose in between sulfur cured EPDM (+ 100°C) or peroxide cured EPDM (+150°C).

### PEROXIDE EPDM

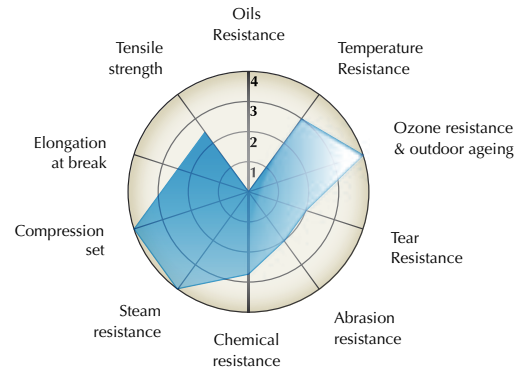

4 : excellent, 3 : good, 2 : average, 1 : bad, 0 : to avoid

### SULFUR EPDM

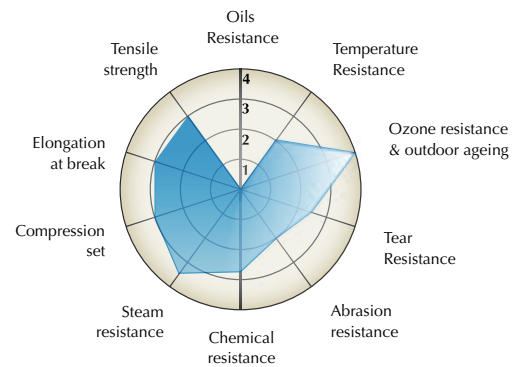

4 : excellent, 3 : good, 2 : average, 1 : bad, 0 : to avoid



## d) FKM (Fluoro elastomer)

### CHARACTERISTICS

FKM is the reference rubber when high temperature or chemical resistance is needed. It is very resistant to UVs, ozone, and outside conditions. It is also very resistant to oils as well as fuels. Its main weakness is its poor resistance to low temperature. However Techné proposes special low temperature FKM to meet your needs. (See table below).

### USES

FKM is unavoidable in the following conditions:

- High temperatures
- Chemical resistance
- Hydraulics
- Rotary sealing
- Hydrocarbon gases with gas approvals.

### DEVELOPMENTS

Techné has a number of specific FKM for steam water, biodiesels, LPG, etc., applications.

### DIFFERENT FKM COMPOUNDS

Fluid & Environment	A 66% Fluorine copolymer	B 68% Fluorine terpolymer	F 70% Fluorine terpolymer	GBL 66% Fluorine terpolymer	GF 70% Fluorine terpolymer	GLT 64% Fluorine terpolymer	GFLT 67% Fluorine low T° terpolymer	ETP 67% fluorine non VF2 terpolymer	XLT 65% fluorine very low T°C terpolymer
	bisphenol cured			peroxide cured					
Aliphatic hydrocarbons, chemicals	1	1	1	1	1	1	1	1	1
Aromatic hydrocarbons (toluene, etc.)	2	1	1	1	1	2	1	1	1
Motor & aircraft fuel (pure without alcohol)	1	1	1	1	1	1	1	1	1
Motor fuels containing 5-15% alcohol & ethers (methanol, ethanol, MTBE, TAME)	2	1	1	1	1	2	1	1	1
Mixed motor fuels up to 300% methanol	NR	2	1	2	1	NR	1	1	1
Engine lubricating oils (grades SE-SF)	2	1	1	2	1	1	1	1	1
Engine lubricating oils (grades SG-SH)	3	2	2	1	1	1	1	1	1
Acid (H2SO4, HNO3), hot water, steam	3	2	2	1	1	1	1	1	1
Asic, basic, caustic or amines solutions	NR	NR	NR	NR	NR	NR	NR	1-2	NR
Low molecular weight carbonyl, 300% Concentration (MTBE, MEK, MIBK, etc.)	NR	NR	NR	NR	NR	NR	NR	1-2	NR
Low temperature sealing capability TR-10 test.	-17°C	-14°C	-7°C	-15°C	-6°C	-30°C	-24°C	-11°C	-40°C

1 : excellent ; 2 : good ; 3 : low ; NR : not recommended

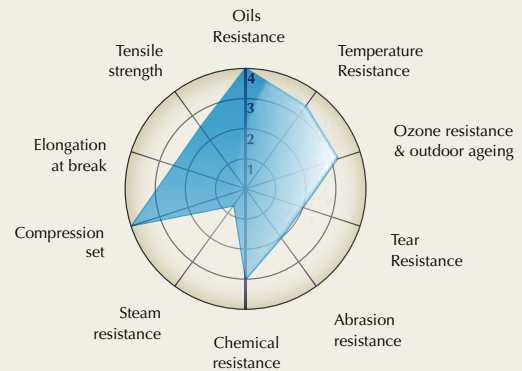

4 : excellent, 3 : good, 2 : average, 1 : bad, 0 : to avoid



## e) FFKM (Perfluoro elastomer)

### CHARACTERISTICS

■ FFKM is used when FKM finds its limitations. FFKM has better resistance to high temperatures, for an almost universal chemical compatibility (except with fluorinated products such as freons). Techné suggests FFKM only when it is the only solution as it is by far the most expensive rubber.

### USES

- Chemical/petrochemical applications
- High temperature steam applications
- Dye or paint applications.

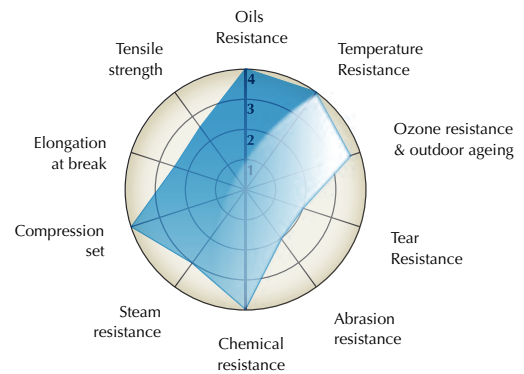

4 : excellent, 3 : good, 2 : average, 1 : bad, 0 : to avoid

## f) VMQ (Silicone)

### CHARACTERISTICS

Silicone has the widest temperature range (-50/+200°C) so it is often used in low as well as in high temperature applications.

### USES

- Food industries (available with FDA approvals)
- Medical devices (available with USP VI approvals)
- Very low temperature
- Aseptic seals.

Silicone offers a weak resistance to oils and chemical products. Depending on the fluid used, Techné proposes FMVQ (fluorinated silicone) which offers a better resistance.

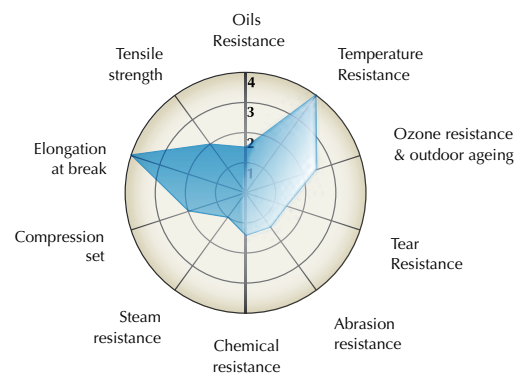

4 : excellent, 3 : good, 2 : average, 1 : bad, 0 : to avoid



## g) FVMQ (Fluorosilicone)

### CHARACTERISTICS

Fluorosilicones has the same characteristics as silicone especially its temperature range (-50/+200°C) but offers a very good chemical and oil resistance.

### USES

- Automotive industry
- Aerospace industry.

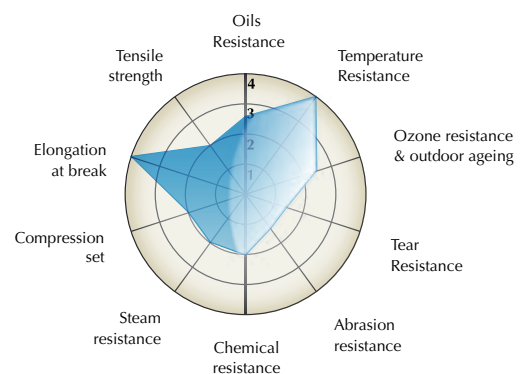

4 : excellent, 3 : good, 2 : average, 1 : bad, 0 : to avoid



## h) CR (Chloroprene)

### CHARACTERISTICS

CR has the property of being a self-extinguishing rubber, as well as being highly resistant to outside conditions, ozone and oils.

### USES

- Electronics which require flames resistance and UL approvals
- Contact with freon
- Naval.

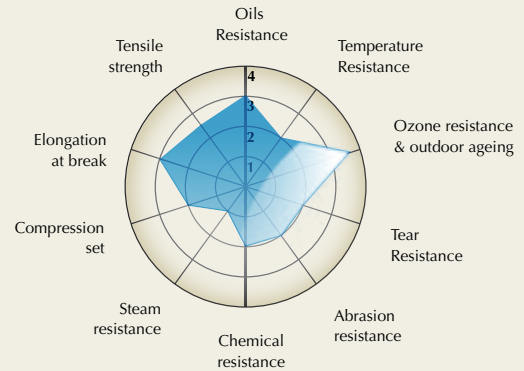

4 : excellent, 3 : good, 2 : average, 1 : bad, 0 : to avoid



## i) IIR (Butyl elastomer)

### CHARACTERISTICS

IIR has a good resistance to outside conditions, ozone and ageing. It has a good compatibility to glycol based brake fluids but not with oils. It is however gas proof.

### USES

- Gas proof
- Steam (valves)
- Outdoor sealing.

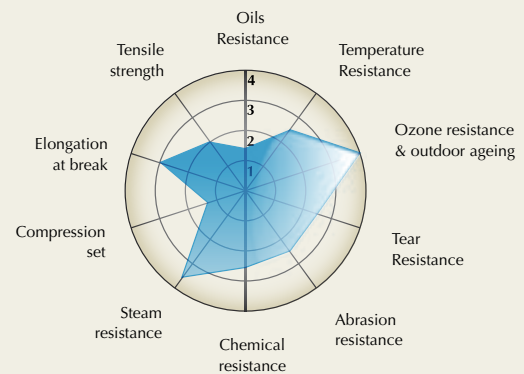

4 : excellent, 3 : good, 2 : average, 1 : bad, 0 : to avoid

## 3. PLASTIC IN THE SEALING WORLD

Plastics or thermoplastics are often used with rubber to obtain a better sealing. It is therefore important to understand their properties.

### a) PTFE (Polytetrafluoroethylene)

#### CHARACTERISTICS

Virgin PTFE has the smallest friction coefficient. It also has an almost universal chemical compatibility, and a very wide temperature range (either low or high temperature, from -200°C up to +250°C) However, it has a poor wear resistance and creeps under load.

To overcome these problems, Techné proposes PTFE charged with bronze, carbon, glass, graphite, MoS<sub>2</sub>, etc.

#### USES

PTFE is often machined to make back up rings. When PTFE is part of a sealing system, it is often associated with a rubber expander (or a metal spring) to give it a better elasticity. (See Techné machined parts catalogue). Virgin PTFE is FDA and/or USP class VI approved.

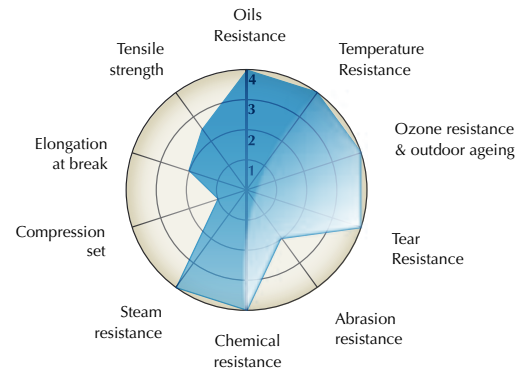

4 : excellent, 3 : good, 2 : average, 1 : bad, 0 : to avoid



### b) TPU (Thermoplastic polyurethane)

#### CHARACTERISTICS

TPU (or PU) are thermoplastic elastomers that combine the elastic properties of elastomers with the mechanical properties of plastics.

The most important properties of PU are its excellent wear resistance. Those properties make this material perfect for machined seals that fit all hydraulic or pneumatic applications.

#### TWO TYPES OF TPU

AU (polyester): has a very good resistance to oils despite being subject to hydrolysis.

EU (polyether): is not subject to hydrolysis but has a lower resistance to oils.

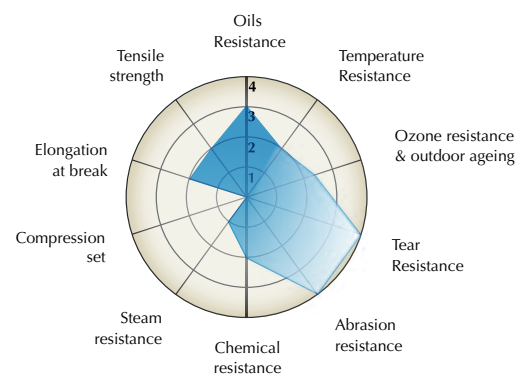

4 : excellent, 3 : good, 2 : average, 1 : bad, 0 : to avoid



## 4. CERTIFICATIONS

In order to meet international standards, Techné offers a wide range of certifications adapted to all applications.

### a) Main standard organisations

#### FDA

The Food and Drugs Administration is a government agency, supervised by the U.S. Department of health, which is responsible for the implantation of the federal laws concerning food, drugs, and cosmetics. Seals in contact with food and drugs must comply with rules issued by the FDA.



#### USP

The United States Pharmacopoeia is an independent scientific public health organisation. It issues the official standards for drugs sold and health products manufactured and/or marketed in the US. The USP is one of the most recognised pharmacopoeias, which makes it a worldwide reference.

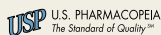

#### 3-A

3-A Sanitary Standards, Inc (3-A SSI) is an American organisation that sets health standards affecting all dairy and food equipments in contact with consumer products. Its purpose is to protect consumer products from contamination and ensure the cleanability of all surfaces.

The seal must already comply with FDA regulation before being eligible for a 3-A certification.



#### NSF

The NSF is a worldwide known organisation for its certification services related to health and safety. Registration with the NSF ensures that products can be safely used in food environments.

The evaluation includes a toxicological examination, an assessment of the accuracy of the labels and safety data sheets.



#### WRAS

The Water Regulations Advisory Scheme (WRAS) is the British approval organisation for the water industry. Tests are conducted in certified laboratories.



#### DVGW

Deutsche Vereinigung of Wasserfaches und Gas (DVGW) is a german independent organisation for the self regulations of the water and gas industry in Europe. It publishes the UBA and W270 test standards for elastomers.



#### ACS

The Accréditation de Conformité Sanitaire (ACS) is a French health standard organisation concerning drinkable water. The standard is used for rubber and plastics in contact with drinking water. The criteria are defined in the French AFNOR XP P41-250 standard, parts 1 to 3.



#### CEN & ISO

The CEN or European Committee for standardisation is an organisation that harmonises the European standards. Its national members are also members of the International Organisation For Standardisation (ISO). It contributes to the goals set out by the EU and the EFTA countries through the development of European technical, EN standards or euronorms. It publishes for elastomers, EN 681-1 (drinking water), EN 549 and EN 682 (gas service). These standards are disclosed in France by AFNOR.



#### CE

Conformité Européenne, means «European Conformity», formerly EC. The European Union describes its own standards following regulations and determines if substances or products can be used in Europe. Regarding the food compatibility, the CE regulation 1935/2004 describes the different standards to be met.

The European Union also publishes the REACH directive (Registration, Evaluation and Authorisation of Chemicals), which concerns the substances used in elastomers.



#### OTHERS

KIWA (drinking water – Netherlands), QAS (Australia-drinking water), TGM (drinking water-Austria), UL (Flame Resistance – America), EN 45 545 (Railway industry), NF L 17107 (Aeronautic industry).

## b) Main certifications

Uses	Standard	Certification	Designation
<b>Food</b>	FDA	FDA	The elastomer seals shall comply with paragraph 21 CFR 177.2600. If the compounds match with the positive list, the seals are FDA approved. However for a FDA certification, a migration test is necessary.
	NSF	NSF 51	A formulation review is performed to check if the product meets the minimum requirements of hygiene for use in food processing facilities.
	CE	1935/2004	Positive list and microbiological testing on finished product that may be in contact with food.
<b>Medical</b>	USP	USP classe VI	An assessment that includes in vivo tests of biological reactivity. This validates the elastomer's compatibility with pharmaceuticals.
<b>Drinking water</b>	NSF	NSF 61	Requires the communication of the complete formulation and the toxicological results of a third party laboratory are reviewed by the NSF.
	DVGW	UBA 1.3.13.	Positive list + taste and extraction tests.
		W270	Microbiologic analysis.
		W534	For products that are in contact with plumbing connections. The elastomer must already be UBA & EN681-1 approved. Then it undergoes a strict compression set test to ensure its durability.
	WRAS	WRAS	The approval of non-metallic materials in contact with drinking water is defined by the BS6920:2000 standard. This standard requires compliance with a positive list, a microbiological test, hot water and extraction test.
	ACS	CLP	Compliance with a positive list. For seals with an outside diameter that is less than 63mm, only.
		ACS	CLP + Migration test. Certification defined by AFNOR XP P41-250, part 1 to 3.
	EN	EN 681-1	A certification for seals used in water pipes. It is divided according to use: <ul style="list-style-type: none"> <li>- WA: For cold water (50°C max)</li> <li>- WB: For domestic hot water (continuous service up to 110°C)</li> <li>- WC: For non drinkable cold water (45°C continuous service, 95°C intermittent service)</li> <li>- WD: For non drinkable hot water (110° C max continuous service).</li> </ul>

Uses	Standard	Certification	Designation
Gas	EN	EN 549	European standard for products in contact with gas. It includes tests for: <ul style="list-style-type: none"> <li>- Hardness</li> <li>- Tensile strength and elongation</li> <li>- Compression set (low and high temperatures)</li> <li>- Air and ageing resistance</li> <li>- Gas resistance</li> <li>- Lubrication resistance (ASTM 2 oil)</li> </ul>
	EN	EN 682	European standard for products used in pipelines and connectors that deliver gas and liquid hydrocarbons. They can be classified according to the application: <ul style="list-style-type: none"> <li>- GA: Gas fuels</li> <li>- GB: Gas fuels and liquid hydrocarbons</li> <li>- GO: H type aromatic hydrocarbons (gas fuels containing condensates).</li> </ul> Working temperatures: <ul style="list-style-type: none"> <li>- From -5 up to 50°C (GA, GB, H)</li> <li>- From -15 up to 50°C (GAL, GBL)</li> </ul> The laboratories test the following properties: <ul style="list-style-type: none"> <li>- Hardness</li> <li>- Tensile strength and elongation</li> <li>- Compression set (low and high temperatures)</li> <li>- Air and ageing resistance</li> <li>- Stress relaxation tests</li> <li>- Volume variation in FUEL B</li> <li>- Volume variation in IRM 903 oil</li> <li>- Ozone resistance.</li> </ul>
Fire	UL	UL 94	This standard classifies plastics and elastomers according to their degree of flammability: <ul style="list-style-type: none"> <li>- HB: slow combustion rate on a horizontal sample; combustion rate &lt;76mm/min for a 3mm thickness</li> <li>- V2: burning stops within 30 seconds on a vertical sample; drops of burning material are tolerated</li> <li>- V1: burning stops within 30 seconds on a vertical sample; drops of material are tolerated as long as they are not burning</li> <li>- V0: burning stops within 10 seconds on a vertical sample; drops of material are tolerated as long as they are not burning</li> <li>- 5VB: stops burning within 60 seconds on a vertical sample; drops are not tolerated; however, a hole can develop on a specimen sheet</li> <li>- 5VA: stop burning within 60 seconds on a vertical; drops and holes are not tolerated on a specimen sheet.</li> </ul>
Railway	EN	EN 45 545	Defines technical expectations: resistance to fire and smoke for products and materials used on trains.
Aeronautic	NF	NF L 17107	This standard classifies elastomers to answer the expectations of aerospace industry. Possible applications and limits are given according to each rubber category. (see file page 45-47)

## c) Techné certifications

Material	Hardness	Number	WRAS	ACS	CLP	EN549	FDA positive list	W270	EN681-1	UL94	EN682	USP	3A	BAM oxygen resistance	1935/2004	Cognac alimen- tarity - BNIC	UBA
Coating	/	666126					X					X					
	/	666138	X				X										
	/	66667	X	X	X		X	X							X		
CR	70	334714								X							
EPDM	50	1178022	X														
EPDM PEROXYDE	40	334332			X		X					X					
	50	72732													X		
	60	117031	X		X		X	X	X								X
	60	11774	X		X		X										
	65	334501	X	X			X	X									X
	70	117029	X	X	X		X	X	X			X	X		X		X
	70	117049	X		X		X	X	X								X
	70	117074	X	X				X	X								X
	70	11720					X										X
	70	11743	X	X	X		X	X	X			X	X				X
	70	334137		X			X		X			X	X		X		X
	70	334601			X												X
	70	334701	X	X	X		X	X				X	X		X		X
	75	72743													X		
	80	11714		X	X		X	X					X				
EPDM PEROXYDE METAL DETECTABLE	70	334607A	X												X		
FKM	60	117011				X											
	60	11748				X											
	60	11775				X											
	60	334666					X								X		
	65	007701					X								X		
	70	11700				X											
	70	11750				X											
	70	72733					X								X		
	70	334786					X					X			X		
	80	33466					X					X	X		X	X	
	80	73257				X								X			
	80	73272					X					X			X		
85	87811					X								X			
MVQ	40	334447										X					
	40	72748					X								X		
	50	334729A					X								X		
	50	72747					X								X		
	60	117061	X		X	X	X	X									X
	60	72730					X								X		
	60	72750					X								X		
	60	72751					X								X		
	70	117070			X	X	X	X									X
	70	1178001	X	X				X									X
	70	72729					X								X		
	70	72731					X								X		

Material	Hardness	Number	WRAS	ACS	CLP	EN549	FDA positive list	W270	EN681-1	UL94	EN682	USP	3A	BAM oxygen resistance	1935/2004	Cognac alimenterarity - BNIC	UBA
MVQ	70	334368					X					X					
	80	334144					X					X	X		X		
	80	72749					X								X		
MVQ platinum	50	334602					X					X			X		
	80	334536					X					X					
	80	334603					X					X			X		
NBR	60	11703				X											
	60	117062				X											
	60	11761				X											
	70	117017			X												
	70	117020				X					X						
	70	117051	X	X	X	X			X		X						
	70	11713				X											
	70	11723	X		X	X	X	X									X
	70	11788				X											
	70	334012B				X					X						
	70	72752			X												
	80	117107				X											
	80	334075B					X								X		
PTFE	/	95109					X					X					
	/	95143		X						X							
	/	95101	X				X	X		X		X	X		X		X
		23413					X	X				X	X		X		
PTFE METAL DETECTABLE	/	23322				X								X			

Non-exhaustive file – Approvals may change without customer prior agreement or information.

### d) Techné certifications for aeronautical applications

Rubber families	Designation		Techné Group	Creat Material	French aeronautical standards	Possible alternative in replacement	Typical use				Other possible uses	Limitations	
	Class	Underclass					Range	Medium		Use T°C			
								Definition	Standards	Long use			Limited use
1 NR / SBR	-	-	-	-	-	-	-	-	-	-	-	-	
2 NBR	20	A	20A5 => 01.4150.xxxx 20A6 => 01.4160.xxxx 20A7 => 01.4170.xxxx 20A8 => 01.4180.xxxx 20A9 => 01.4190.xxxx	20A5 => 72704 20A6 => 72705 20A7 => 72706 20A8 => 72707	NF L17-120	21A - 21B 26B - 26C 60C - 61D 65C	Mineral based hydraulic fluid and synthesis hydrocarbons	DCSEA 415	-30 / +120°C	-30 / +140°C	- Resistance to other mineral based petroleum fluids : excellent to average depending on the category ; - Resistance to some types of halogenated solvents, to ethylene glycol based liquids : cooling system.	- Poor resistance to atmospheric agents ; - Forbidden use with hydraulic fluids type phosphoric ester (Permanent or temporary immersion, projections, etc.).	
		B	20B5 => 01.4151.xxxx 20B6 => 01.4161.xxxx 20B7 => 01.4171.xxxx 20B8 => 01.4181.xxxx 20B9 => 01.4191.xxxx	20B5 => 72708 20B6 => 72709 20B7 => 72710 20B8 => 72711					-50 / +100°C	-50 / +120°C			
	21	A	21A6 => 01.4162.xxxx 21A7 => 01.4172.xxxx 21A8 => 01.4182.xxxx 21A9 => 01.4192.xxxx	21A6 => en cours au 15/03/2016 21A7 => 72712	NF L17-121	60C - 61D 63D - 65C 66B	Petroleum fuel Diesters lubricants 100-130 fuel JP1 JP4 Turbine synthetic oil	DCSEA 118 DCSEA 134 AIR 3407 AIR 3514	-20 / +120°C	-20 / +140°C			
		B	21B4 => 01.4143.xxxx 21B6 => 01.4163.xxxx 21B8 => 01.4183.xxxx	21B6 => 72713					-40 / +100°C	-20 / +140°C			
	23	B	23B7 => 01.4174.xxxx	23B7 => 72714	NF L17-123	-	Diesters lubricants	AIR 3514	-50 / +120°C	-50 / +140°C			
	24	B	24B7 => 01.4175.xxxx		NF L17-124	21A - 21B 26B - 26C 60C - 61D 65C	Mineral based hydraulic fluid and synthesis hydrocarbons	DCSEA 415	-50 / +120°C	-50 / +140°C			
25	B			Suppressed class									

Rubber families	Designation		Techné Group	Creat Material	French aeronautical standards	Possible alternative in replacement	Typical use				Other possible uses	Limitations				
	Class	Underclass					Range	Medium		Use T°C						
								Definition	Standards	Long use			Limited use			
2 HNBR	26	B	6 - 7 8 - 9	26B6 => 01.4960.xxxx 26B7 => 01.4970.xxxx 26B8 => 01.4980.xxxx 26B9 => 01.4990.xxxx	-	NF L17-126	-	Petroleum fuels	-	-30 / +120°C	-50 / +125°C	- Resistance to other mineral based petroleum fluids : excellent to average depending on the category ; - Resistance to some types of halogenated solvents, to ethylene glycol based liquids : cooling system ; - Improved resistance to atmospheric agents and to peroxide fuels.	- Forbidden use with hydraulic fluids type phosphoric ester (Permanent or temporary immersion, projections, etc.).			
		C	6 - 7 8 - 9	26C6 => 01.4961.xxxx 26C7 => 01.4971.xxxx 26C8 => 01.4981.xxxx 26C9 => 01.4991.xxxx	-	-	-	-	-20 / +150°C	-40 / +175°C	-	-				
3 CR	31	B	3 - 4 5 - 6 7 - 8	31B3 => 01.4430.xxxx 31B4 => 01.4440.xxxx 31B5 => 01.4450.xxxx 31B6 => 01.4460.xxxx 31B7 => 01.4470.xxxx 31B8 => 01.4480.xxxx	31B4 => 72739 31B5 => 72736 31B6 => 72740 31B7 => 72741	NF L17-131	20B - 23B 24B - 50D 52D - 54D 60C - 61D 63D	Atmospheric agent Petroleum fuels Turbine and piston engine oil	AIR 3512 AIR 3560	-40 / +100°C	-40 / +120°C	- Air circuit ; - Resistance to flame propagation : average to excellent ; - Resistance to the different fluids projections	- Poor resistance to fuels and petroleum fluids with weak and average aniline points in case of total immersion.			
				32	A	5 - 7	32A5 => 01.4451.xxxx 32A7 => 01.4471.xxxx	-	NF L17-132	-	Dielectric use	-	-30 / +100°C	-30 / +120°C	-	- Use only dedicated to the typical use
4 EPDM	41	B	6 - 7 8 - 9	41B6 => 01.4560.xxxx 41B7 => 01.4570.xxxx 41B8 => 01.4580.xxxx 41B9 => 01.4590.xxxx	41B8 => 72715	NF L17-241	42B - 44B	Hydraulic fluid Phosphoric ester type	-	-	-55 / +150°C	- Resistance to atmospheric agents ; - Air circuits.	- Poor elasticity limiting the possibilities of using dynamic seals and profiles ; - Forbidden use with petroleum fluids.			
				42	B	5 - 6 7 - 8 9	42B5 => 01.4551.xxxx 42B6 => 01.4561.xxxx 42B7 => 01.4571.xxxx 42B8 => 01.4581.xxxx 42B9 => 01.4591.xxxx	-	NF L17-242	41B	Atmospheric agents Hot air	-	-55 / +125°C	-55 / +160°C	- Resistance to fluid projections, type phosphoric ester.	- Not recommended in immersion in fluids like phosphoric ester (shrinkage risk).
				44	B	7 - 8	44B7 => 01.4572.xxxx 44B8 => 01.4582.xxxx	-	NF L17-144	-	Hydraulic fluid Phosphoric ester type (colored material)	-	-55 / +100°C	-55 / +150°C	- Resistance to atmospheric agents ; - Air circuits.	-
5 VMQ	50	D	4 - 5 6 - 7 8	40D4 => 01.4240.xxxx 50D5 => 01.4250.xxxx 50D6 => 01.4260.xxxx 50D7 => 01.4270.xxxx 50D8 => 01.4280.xxxx	50D5 => 72724 72770 50D6 => 72718 50D7 => 72725	NF L17-250	41B	Atmospheric agents Hot air Dielectric use	-	-55 / +225°C	-55 / +260°C	- Resistance to high aniline point petroleum lubricants up to 150°C ; - Resistance to other petroleum fluids projections ; - Resistance to phosphoric esters projections.	- Poor mechanical characteristics limiting some uses ; - Forbidden use with fuels and petroleum fluids, in low and average aniline point, in case of total immersion.			
				52	D	5	52D5 => 01.4251.xxxx	52D5 => 72719	NF L17-250	-	Atmospheric agents Hot air Good tear resistance	-	-55 / +200°C	-55 / +225°C	- Hot air circuits, cabin access door (except for Class 54) ; - Resistance to high aniline point petroleum lubricants up to 150°C ;	- Average mechanical characteristics, limiting some uses ; - Forbidden use with fuels and petroleum fluids, in low and average aniline point, in case of total immersion.
				53	D	5	53D5 => 01.4252.xxxx	53D5 => 72720	NF L17-153	-	Atmospheric agents Hot air Good resistance to the flame propagation	-	-70 / +200°C	-70 / +225°C	- Resistance to other petroleum fluids projections ; - Resistance to phosphoric esters projections.	-
				54	D	4 - 5 6 - 7	54D4 => 01.4243.xxxx 54D5 => 01.4253.xxxx 54D6 => 01.4263.xxxx 54D7 => 01.4273.xxxx	-	NF L17-154	-	Atmospheric agents Hot air Dielectric use	-	-55 / +250°C	-55 / +300°C	-	-



6 Fluororubbers

Rubber families	Designation		Range	Techné Group	Creat Material	French aeronautical standards	Possible alternative in replacement	Typical use				Other possible uses	Limitations
	Class	Underclass						Medium		Use T°C			
								Definition	Standards	Long use	Limited use		
FKM	60	C	7 - 9	60C7 => 01.4370.xxxx 60C8 => 01.4390.xxxx	60C7 => 72716	NF L17-260	66B	Petroleum fluids, hydraulic fluids, lubricants, fuels, etc. Diester lubricants	AIR 3514	-20 / +200°C	-20 / +260°C	- Resistance to atmospheric agents, to hot air ; - Resistance to very different fluids ; - Dielectric uses.	- Forbidden use with hydraulic fluids like phosphoric ester (permanent or temporary immersion, projections, etc.) ; - Poor elasticity at temperatures lower than +20°C limiting some uses.
FMVQ	61	D	6 - 7 - 8	61D6 => 01.4264.xxxx 61D7 => 01.4274.xxxx 61D8 => 01.4284.xxxx	61D6 => 72721 61D8 => 72722	NF L17-261		Petroleum fluids, hydraulic fluids, lubricants, fuels, etc.	-	-55 / +180°C	-55 / +200°C	- Resistance to atmospheric agents, to hot air ; - Good to average resistance to petroleum fluids depending on the fluid.	- Poor mechanical characteristics limiting some uses ; - Forbidden use with hydraulic fluids like phosphoric ester (permanent or temporary immersion, projections, etc.) .
Halocarbons	62	A	6	62A6 => 01.4265.xxxx	-	NF L17-164	-	Smoking red nitric acid	-	-10 / +50°C	-10 / +120°C	-	- Use only dedicated to the typical use.
FMVQ	63	D	6	63D6 => 01.4266.xxxx	63D6 => 72723	NF L17-163	66B	Petroleum fluids, hydraulic fluids, lubricants, fuels, etc. Good tear resistance	-	-55 / +150°C	-55 / +200°C	- Resistance to atmospheric agents, to hot air ; - Good to average resistance to petroleum fluids depending on the fluid.	- Average mechanical characteristics, limiting some uses ; - Forbidden use with hydraulic fluids like phosphoric ester (permanent or temporary immersion, projections, etc.) .
FKM	64	C	6 - 8	64C6 => 01.4361.xxxx 64C8 => 01.4381.xxxx	64C8 => 72717	NF L17-164	-	Petroleum fluids, hydraulic fluids, lubricants, fuels, etc. Diester lubricants	AIR 3514	-20 / +230°C	-20 / +260°C	- Resistance to atmospheric agents, to hot air ; - Resistance to very different fluids ; - Dielectric uses ; - Improved creep resistance compared to Class 60°C.	- Forbidden use with hydraulic fluids like phosphoric ester (permanent or temporary immersion, projections, etc.) ; - Poor elasticity at temperatures lower than +20°C limiting some uses.
	65	C	8	65C8 => 01.4382.xxxx	-	NF L17-165	-	Improved resistance to diester lubricants	AIR 3514	-10 / +230°C	-10 / +260°C	-	- Forbidden use with hydraulic fluids like phosphoric ester (permanent or temporary immersion, projections, etc.) ; - Poor elasticity at temperatures lower than +10°C limiting some uses.
	66	B	7 - 8	66B7 => 01.4373.xxxx 66B8 => 01.4383.xxxx	-	NF L17-166	-	Very good resistance to cold in petroleum and hydraulic fluids, fuels etc	-	-30 / +220°C	-35 / +250°C	- Heat and hydrocarbons resistance ; - Resistance to very different fluids.	-
FFKM	67	C	7	-	-	NF L17-167	-	Excellent resistance to heat and high temperature engine oils	-	+5 / +300°C	0 / +320°C	- Exceptional resistance to very different fluids.	- Low temperatures.



6  
Processes

18  
Development

26  
Materials

## Coatings

50

### coatings

- 51 T-surf®
- 52 T-color®
- 53 T-Lub®
- 54 T-coat®
- 56 Summary table

# 1. COATINGS

50



Easy installation, cleanliness, low friction, identification, customisation, improved service life and sliding properties are just as important as the sealing itself. In these cases, Techné becomes the best partner with its coatings workshop.

## a) T-surf®

**T**echné T-surf treatment guarantees seals free from any contaminating substances which could damage paint or electronic instruments. They meet the cleanliness and non contamination requirements of the electronic and automotive industry. The original properties of the material – mechanical properties, alimentary, and certifications- are preserved.

### ✓ T-surf® SW

A thorough cleaning (with water and special detergents) that removes all traces of impurity and greasy substances from the treated parts. Mainly used in industrial applications that requires an enhanced cleanliness.

### ✓ T-surf® CRW

This treatment is performed in an ISO Class 7 cleanroom. It consists in removing all traces of impurity and greasy substances from the treated parts. It is delivered with a specially adapted double packaging. It is mostly used in food related applications.

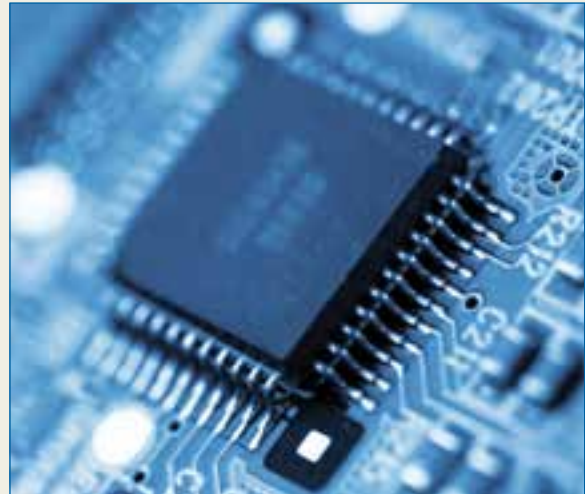

### ✓ T-surf® UW

Ultra-sonic washing and packaging is performed in an ISO Class 7 cleanroom. This treatment significantly improves the cleanliness of the products. It is widely used in the food and medical industries.

### ✓ T-surf® L

This treatment is performed using an ion generator for an in depth decontamination of Techné's rubber parts. It is used on parts that are going to be painted or that will be used in electronic instruments.

*Coating  
preparation*



## b) T-color®

A coloured coating is applied on the part. Before doing so, the surface of the part is activated to ensure a better binding. This coating allows a better identification of the seals while maintaining the original properties of the elastomer. This coating also improves the friction properties of the part. The colour resists to dynamic and mechanical stress. Techné works with RAL and PANTONE colour charts. Try it!

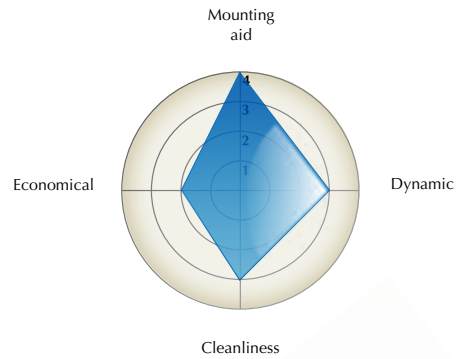

## ✓ T-color® PG

This is a colourable PTFE based surface treatment that forms a dry, yet slippery coating. The chosen colour will help for a quick visual identification. The lubricating substances in the coating will ease the mounting of the seals. The T-color PG also reduces the stick-slip effect. It is therefore perfect for all dynamic applications.

4 : excellent, 3 : good, 2 : average, 1 : bad, 0 : to avoid

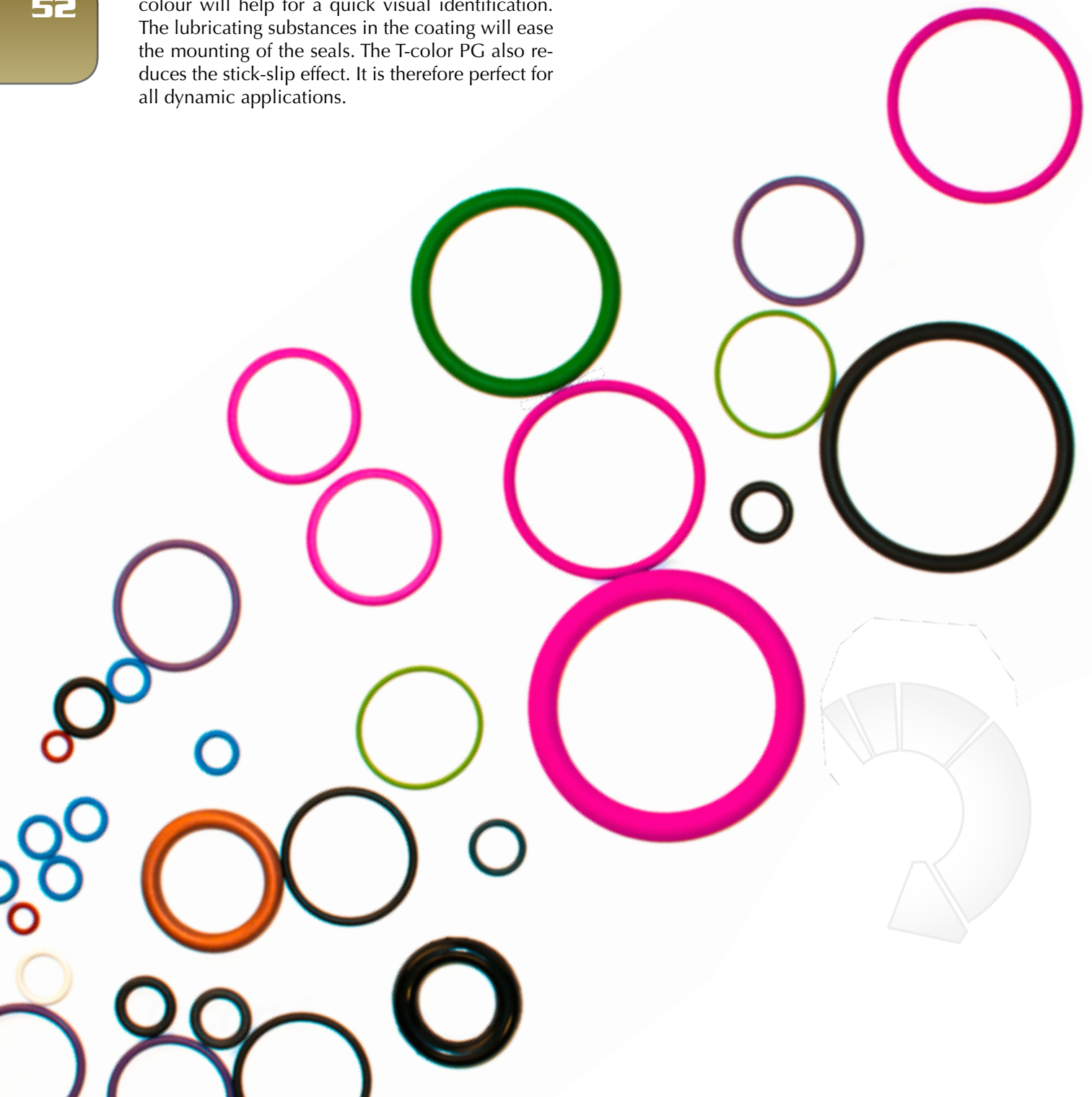

### c) T-Lub®

This coating eases the mounting of the parts for a small additional cost. The deposited lubrication agents are not physically linked with the material itself. After time, the coating is less efficient. For all your dynamic applications, chose a T-coat solution.

#### ✓ T-Lub® SA

A transparent silicone oil based coating. This USP Class VI alimentary coating has a viscous and shiny appearance. This outstanding lubrication agent reduces the effort of assembly. It is exclusively used as a mounting help.

#### ✓ T-Lub® M

A MoS<sub>2</sub> (molybdenum disulfide) based silver coating. This coating is dry and shinny. The solid particles on the surface of the part will considerably reduce mounting efforts. This coating performs well in high temperature and humid environments. The possible migration on the surface in contact also eliminates any sticking phenomenon.

#### ✓ T-Lub® T

A pharmaceutical quality talc-based coating. Talc is an excellent separation agent that avoids parts sticking together. The talc particles fill the interstices of the parts providing a slippery and soft effect. Mainly used to help the assembly, it is an economical solution.

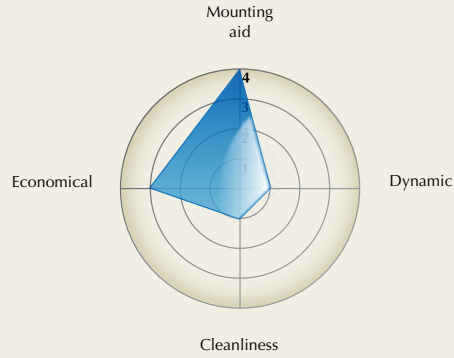

4 : excellent, 3 : good, 2 : average, 1 : bad, 0 : to avoid

#### ✓ T-Lub® GA

A transparent coating made from PTFE particles. A non-messy and slippery dry film is applied. It allows an easy mounting, thanks to its dry and clean lubrication. It is mainly used as a mounting aid.

Vibratory bowl feeder



## d) T-coat®

T-coat® are a half-permanent or permanent lubricating coatings. These coatings are able to meet simple mounting requirements or high stress dynamic applications. The parts will keep all their initial properties but with a lower friction coefficient and a better wear resistance. The stick-slip effect no longer occurs. As for the T-surf® treatment, the T-coat® meet non contamination regulations required in the automotive and electronic industry.

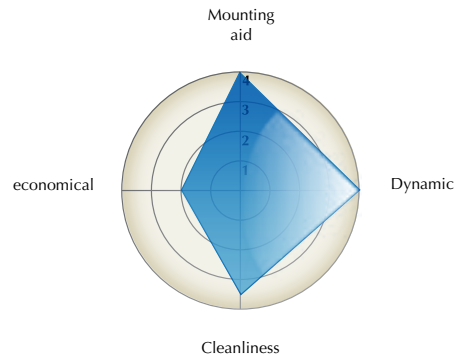

4 : excellent, 3 : good, 2 : average, 1 : bad, 0 : to avoid

54

### ✓ T-coat® PP

A transparent PTFE based surface coating. This half-permanent coating applied to the part is dry, dull and non-contaminating. It is perfect for production lines. It offers a quick mounting and avoids cuts and tearing. Half-permanent, it prevents sticking (stick-slip effect).

### ✓ T-coat® PPA



A colourless PTFE-based coating. This half-permanent coating forms a dry film which is non-contaminating and food compatible. It eases mounting thanks to a low friction coefficient. The anti-sticking agent also prevents from stick-slip effects.

### ✓ T-coat® P

Transparent PTFE based coating. This coating is dry and shiny. Non polluting, it is ideal for automatic high speed mounting. It also prevents assembly defects thanks to the following properties:

- High sliding properties
- Small friction coefficient
- Noise reduction.

The excellent link to the material itself ensures the coating's resistance to both mechanical and dynamic stress.

### ✓ T-coat® PA

A slightly white PTFE based coating. This dry coating is recommended for food and drinking water applications. The high quality particles used in the coating facilitates the assembly of the parts and reduces frictional forces. This coating prevents sticking and the stick-slip effects in food appliances. This coating is permanent and allows low stress dynamic use. This coating is distinguished by its different certifications: W270, ACS, WRAS, NSF, KTW and FDA.





### ✓ T-coat® PSN

A transparent PTFE/silicone/graphite based coating. This coating is dry, smooth and shiny. It can be used to help the mounting and also to prevent any stick-slip effects. It allows small and medium dynamic stress.

### ✓ T-coat® PX

A black PTFE and graphite based coating. This coating is dry, slightly grainy and dull. The high-tech material used in for this coating offers a remarkable wear resistance as well as an excellent friction coefficient. This coating meets the simplest, as well as the strictest requirements:

- No stick-slip effect
- Noise reduction
- Intense dynamic applications
- Increase product life time
- Energy saving.



### ✓ T-coat® SPH

A translucent silicone based coating. This coating is dry, smooth and mat. It can be used to help the mounting and to prevent any stick-slip effect. It allows small and medium dynamic stress. This coating has been developed for the medical and pharmaceutical industry (coating of silicone parts).

### ✓ T-coat® LN

A PPXn based translucent coating. This coating is dry, smooth and mat. It can be used to help the mounting and to prevent any stick-slip effect. It allows small and medium dynamic stress.

## e) Summary table

		T-surf®	T-Lub®			
			SA	M	T	GA
Look	Base	No added layer on the treated material	PTFE	Silicon	Talc	PTFE
	Colour		Transparent	Silver	White	Satin
	Appearance		Greasy Glossy Smooth	Dry Glossy Smooth	Dry Powde- red	Dry Smooth
	Thickness (about)		5 µm	5 µm	5 µm	5-10 µm
Properties	Temperature (°C) <sup>1</sup>		-40 to 200°C	-180 to 250°C	-180 to 250°C	-40 to 120°C
	Labs-free <sup>1,3</sup>	yes	no	no	no	yes
	Certifications <sup>1,2</sup>	Certifications of the treated material		FDA		
Uses	Improvement of Static COF (Coefficient of Friction) <sup>4</sup>	No added layer on the treated material				
	Anti-stick-slip					
	Improvement of dynamic COF (Coefficient of Friction) <sup>4</sup>					
	Automatic assembly (separation of the parts)		■ ■ □ □ □ □ □ □	■ ■ □ □ □ □ □ □	■ ■ □ □ □ □ □ □	■ ■ ■ □ □ □ □ □
	Reduction of static assembly force <sup>4</sup>		-60%	-50%	-20%	-60%
	Easy assembly		■ ■ ■ ■ ■ □ □ □	■ ■ ■ ■ ■ □ □ □	■ ■ ■ □ □ □ □ □	■ ■ ■ ■ ■ □ □ □
	Reduction of dynamic force <sup>4</sup>					
	Lifetime duration		□ □ □ □ □ □ □ □	■ □ □ □ □ □ □ □	■ □ □ □ □ □ □ □	■ ■ □ □ □ □ □ □
	Elongation resistance			> 150%		

1 Depends on the used material.

2 Will probably change depending on the applicable laws.

3 Certified without plasticizers or silicone.

4 Average of the measurements taken on the Techné approved test assembly. Gain % compared to parts without coatings. Can change depending on mating materials, tightening & applications.

5 Techné can supply a T-coat PX with an even better high temperature.

T-Coat®								T-Color®
PP	PPA	P	PA	PSN	PX	SPH	LN	PG
PTFE	PTFE	PTFE	PTFE	Graphite / Silicon	PTFE	Silicon	PPXn	PTFE
Translucent	Translucent	Translucent	White layer	Black layer	Black	Translucent	Translucent	acc. customer choice
Dry Mat Smooth	Dry Bright Smooth	Dry Bright Smooth	Dry Smooth	Dry Bright Smooth	Dry Bright Rough	Dry Mat Smooth	Dry Mat Smooth	Dry Bright Smooth
5-10 µm	5-10 µm	10-20 µm	10-20 µm	10-25 µm	10-25 µm	3-15 µm	0,3-3 µm	10-30 µm
-40 to 120°C	-180 to 250°C	-40 to 150°C	-40 to 200°C	-40 to 150°C	-40 to 150°C	-40 to 260°C	-40 to 80°C	-40 to 150°C
yes	yes	yes	no	no	yes	no	yes	yes
	FDA - 1935 /2004		FDA - 1935/2004 - UBA - W270 - NSF H1 - ACS - WRAS			FDA - USPVI - ISO10993	FDA - USPVI - ISO10993	
-40%	-40%	-50%	-50%	-50%	-70%	-50%	-70%	-40%
■ ■ ■ ■ □ □ □ □	■ ■ ■ ■ □ □ □ □	■ ■ ■ ■ ■ □ □ □	■ ■ ■ ■ ■ □ □ □	■ ■ ■ ■ ■ □ □ □	■ ■ ■ ■ ■ ■ □ □	■ ■ ■ ■ ■ □ □ □	■ ■ ■ ■ ■ ■ □ □	■ ■ ■ ■ □ □ □ □
-40%	-40%	-50%	-50%	-50%	-70%	-50%	-70%	-40%
■ ■ ■ ■ □ □ □ □	■ ■ ■ ■ □ □ □ □	■ ■ ■ ■ ■ □ □ □	■ ■ ■ ■ ■ □ □ □	■ ■ ■ ■ ■ □ □ □	■ ■ ■ ■ ■ ■ □ □	■ ■ ■ ■ ■ □ □ □	■ ■ ■ ■ ■ ■ □ □	■ ■ ■ ■ □ □ □ □
-10%	-10%	-30%	-30%	-70%	-60%	-30%	-30%	-20%
■ ■ □ □ □ □ □ □	■ ■ □ □ □ □ □ □	■ ■ ■ □ □ □ □ □	■ ■ ■ □ □ □ □ □	■ ■ ■ ■ ■ ■ □ □	■ ■ ■ ■ ■ □ □ □	■ ■ ■ □ □ □ □ □	■ ■ ■ □ □ □ □ □	■ ■ ■ □ □ □ □ □
-20%	-20%	-60%	-60%	-80%	-80%	-40%	-50%	-50%
■ ■ ■ □ □ □ □ □	■ ■ ■ □ □ □ □ □	■ ■ ■ ■ ■ □ □ □	■ ■ ■ ■ ■ □ □ □	■ ■ ■ ■ ■ ■ ■ □	■ ■ ■ ■ ■ ■ ■ □	■ ■ ■ ■ □ □ □ □	■ ■ ■ ■ ■ □ □ □	■ ■ ■ ■ ■ □ □ □
> 150%								

This information is on a guidance basis only. Do not tend simultaneously to the limit of all the properties of the material. Not all the Techné treatments are presented here. Techné offers more specific treatments on customer demand.



**Part II**

Standard  
**Products**



Lined writing area consisting of multiple horizontal lines for text entry.

# O-Rings

62



78

JT4 X-Rings



84

Backup Rings (BAE)



94

Rubber Cord



96

JR Fitting Seals



100

Bonded Seals



108

Triclover Clamp Seals



114

O-Ring Seals



118

SMS Seals



122

Macon Seals

126

Aseptic O-Rings DIN 11864

# 1. O-RINGS

## a) Definition

Widely used in the industry, Techné O-Ring is a seal with a round shaped cross section. Its main use is static sealing in liquid or gaseous environments. Or as a second class dynamic sealing in a rotating or translating system.

## b) Characteristics

### ✓ Designation

An O-Ring is characterised by two dimensions:

- The internal  $\varnothing d$
- The cross-section  $\varnothing S$

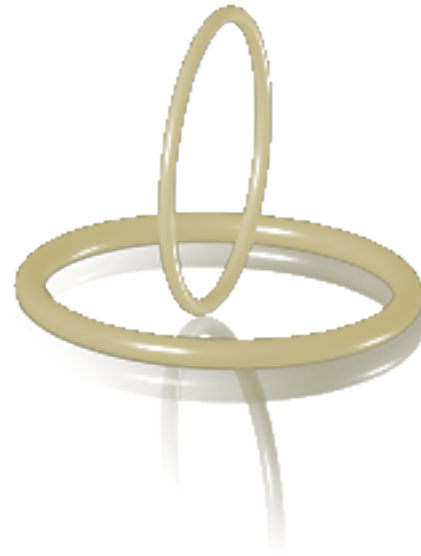
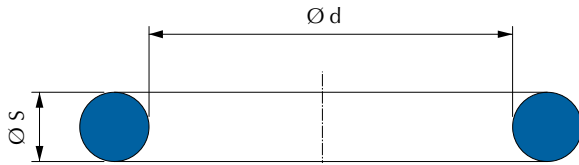

An O-Ring is designated in the following format:

**$\varnothing d \times \varnothing S$**

Example: 18 x 2.62

These dimensions usually meet the following standards:

- R = French references
- BS = 1806 or 4518
- A = AS 568 A
- AN = 6227
- ISO = 3601 (see table page 87)

For groove sizing and mountings data, see page 68.

## c) Production

### ✓ Manufacturing process

To manufacture its O-Rings, Techné uses two processes: compression or injection. To know more about these processes see chapter "processes", page 6.

For specific dimensions, short notices, or polymer seals (PA, POM, etc...) Techné offers a machined fabrication. In this case the hardness of the rubber would be around 83 IRHD.

### ✓ Coating

The mounting of the seals is an important step. That is why Techné provides T-Lub® coatings that facilitate the mounting. (ex, automatic assembly in vibrating bowl). Moreover Techné can answer to all your demands in terms of colours, sliding properties, etc. by adding our coatings on the seal. To better choose the coating that meets your demand, see "coatings", page 50.



## ✓ Quality control

Techné is equipped with a full range of inspection tools in order to monitor its O-Rings. The inspection is done according to AQL1 level 2.

### ASPECT INSPECTION

Visual defects on O-Rings are inspected according to the ISO 3601-3 :2005 grade N.

### DIMENSIONAL INSPECTION

Dimensions of Techné O-Rings include Class B tolerances according to the ISO 3601-1: 2008. For special requirements, Techné can deliver Class A seals. For precision seals that do not meet general industry requirements, see page 67.

## ✓ Material

### CERTIFICATIONS

Depending on the material of the O-Ring, Techné offers different certifications in order to answer the different food, water, gas, medical and fire regulations. See certification table 44.

### MATERIAL TABLE

Material	Colour	Hardness (IRHD)							
		35	40	50	60	70	75	80	90
NBR	Black	01.0135	01.0140	01.0150	01.0160	01.0170	01.0175	01.0180	01.0190
	White	/	/	3	3	01.0172	3	3	3
NBR ozone resist	Black	/	/	/	3	01.1170	3	01.1180	01.1190
NBR low t°C	Black	/	/	/	3	01.7170	3	3	3
FKM	Black	/	/	01.0350	01.0360	01.0370	3	01.0380	01.0390
	Brown	/	/	3	01.0362	01.0377	3	01.0386	01.0392
	Green			01.0355	01.0365	01.0371 01.0375	01.0378	01.0381 01.0385	01.0395
FKM GLT	Black	/	/	/	3	01.3700	01.3750	3	3
FFKM	Black	/	/	/	3	01.0202	3	01.0203	01.0205
	White	/	/	/	3	3	01.0206	01.0204	3
EPDM	Black	/	/	01.0550	01.0560	01.0570	3	01.0580	01.0590
CR	Black	/	/	01.0450	01.0460	01.0470	01.0745	01.0480	01.0490
Silicone MVQ	Red <sup>1</sup>	01.0235	01.0240	01.0250	01.0260	01.0270	3	01.0280	3
	White	3	3	3	01.0262	01.0272	3	3	3
	Blue	3	3	3	3	01.0278	3	3	3
FMVQ	<sup>2</sup>	/	/	/	3	01.0275	3	3	3
ACM	Black	/	/	/	01.0760	3	3	3	3
AEM	Black	/	/	/	3	3	3	01.0859	3

<sup>1</sup>Black, on demand ; <sup>2</sup>Black or blue, on demand ; <sup>3</sup>On demand.

Possibility to supply other hardnesses and materials (Butyl, PTFE, POM, PA, PU, etc).

## d) Dimensions &amp; tolerances

Indicative tolerances of cross-section  $\varnothing S$ , according to ISO 3601-1:2008 class B.

$\varnothing S \leq$	0.5	0.8	2.25	3.15	4.5	6.3	8.4	>8.4
Tolerances $\pm$	0.06	0.07	0.08	0.09	0.1	0.13	0.15	2%

Indicative tolerance of internal  $\varnothing d$  according to standard ISO 3601-1:2008 class B.

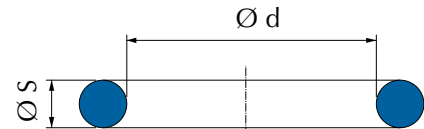

$\varnothing d$	$\pm$	$\varnothing d$	$\pm$	$\varnothing d$	$\pm$	$\varnothing d$	$\pm$	$\varnothing d$	$\pm$
0,4	0,11	48	0,47	98,6	0,82	148	1,15	202,56	1,51
0,6	0,12	49,4	0,48	100,2	0,83	149,2	1,16	204	1,52
1,75	0,13	50,75	0,49	101,9	0,84	151	1,17	206	1,53
3	0,14	52,2	0,5	1025	6,63	152,5	1,18	206,8	1,54
4,2	0,15	53,57	0,51	103	0,85	155,5	1,2	208,6	1,55
5,5	0,16	55	0,52	104,5	0,86	157	1,21	210	1,56
6,75	0,17	56,5	0,53	106	0,87	158,2	1,22	211,54	1,57
8,1	0,18	58	0,54	1060	6,84	159,8	1,23	213	1,58
9,4	0,19	59,3	0,55	107,5	0,88	161,3	1,24	214,5	1,59
10,69	0,2	61	0,56	109	0,89	163	1,25	216	1,6
11,95	0,21	62,2	0,57	110,49	0,9	164,2	1,26	218	1,61
13,3	0,22	63,8	0,58	112	0,91	165,8	1,27	219	1,62
14,8	0,23	65,09	0,59	113,5	0,92	167,5	1,28	220,5	1,63
15,98	0,24	66,5	0,6	115	0,93	169	1,29	222	1,64
17,3	0,25	67,95	0,61	116,5	0,94	170,69	1,3	223,8	1,65
18,7	0,26	69,4	0,62	118	0,95	171,92	1,31	226	1,66
20,1	0,27	71	0,63	119,4	0,96	173,52	1,32	227	1,67
21,5	0,28	72,39	0,64	121	0,97	175	1,33	228,19	1,68
23	0,29	73,8	0,65	123	0,98	177	1,34	230	1,69
24,2	0,3	75,56	0,66	123,8	0,99	177,82	1,35	231,47	1,7
25,5	0,31	77	0,67	125,5	1	179,5	1,36	233	1,71
27	0,32	78,2	0,68	126,7	1,01	181	1,37	234,3	1,72
29,7	0,34	79,7	0,69	129	1,02	182,5	1,38	236	1,73
31,12	0,35	81	0,7	129,77	1,03	184	1,39	238	1,74
32,4	0,36	82,5	0,71	131,2	1,04	185,4	1,4	239	1,75
33,8	0,37	84	0,72	132,71	1,05	187	1,41	240,67	1,76
35,2	0,38	86	0,73	134,2	1,06	188,5	1,42	242	1,77
36,7	0,39	87	0,74	135,76	1,07	190	1,43	244	1,78
38	0,4	88,49	0,75	137,7	1,08	191,72	1,44	246	1,79
39,4	0,41	89,96	0,76	138,94	1,09	193	1,45	247	1,8
40,87	0,42	91,44	0,77	141	1,1	195	1,46	249	1,81
42,5	0,43	92,7	0,78	142	1,11	196,2	1,47	249,7	1,82
43,67	0,44	94,2	0,79	144	1,12	197,96	1,48	252	1,83
45,04	0,45	95,8	0,8	145	1,13	199,1	1,49	253	1,84
46,5	0,46	97,2	0,81	146,2	1,14	201	1,5	255	1,85

Ød	±	Ød	±	Ød	±	Ød	±	Ød	±
256	1,86	339	2,39	418,5	2,9	516	3,51	605	4,06
258	1,87	340	2,4	421	2,91	518	3,52	606	4,07
259	1,88	342	2,41	422	2,92	519	3,53	607	4,08
260,9	1,89	343	2,42	424	2,93	521	3,54	610	4,09
263,35	1,9	344,5	2,43	425	2,94	522	3,55	612	4,11
264	1,91	347	2,44	426,5	2,95	524	3,56	614	4,12
265,5	1,92	348	2,45	428	2,96	526	3,57	616	4,13
266,7	1,93	349,2	2,46	430	2,97	526,7	3,58	618	4,14
268,6	1,94	351	2,47	431,8	2,98	529,3	3,59	620	4,16
270	1,95	353	2,48	433	2,99	530	3,6	622	4,17
272	1,96	354,5	2,49	435	3	532	3,61	624	4,18
273	1,97	355,6	2,5	451	3,1	534	3,62	625	4,19
275	1,98	358	2,51	452	3,11	535	3,63	629,3	4,21
276	1,99	359	2,52	454	3,12	538	3,65	630	4,22
278	2	361	2,53	455	3,13	540	3,66	632	4,23
279,1	2,01	362	2,54	457	3,14	542	3,67	633	4,24
281	2,02	364	2,55	459	3,15	543	3,68	635	4,25
282,54	2,03	365	2,56	460	3,16	545	3,69	636	4,26
284	2,04	367	2,57	462	3,17	548	3,71	637,9	4,27
286	2,05	368,67	2,58	463	3,18	549,5	3,72	640	4,28
288,8	2,07	370	2,59	465	3,19	552	3,73	642	4,29
290	2,08	372	2,6	468	3,21	553	3,74	643	4,3
291,47	2,09	373	2,61	470	3,22	554	3,75	645	4,31
293	2,1	374,9	2,62	472	3,23	556	3,76	646	4,32
295	2,11	376	2,63	474	3,24	557,61	3,77	648	4,33
296,3	2,12	378	2,64	475	3,25	559	3,78	650	4,34
297,8	2,13	379,2	2,65	478	3,27	561,5	3,79	651	4,35
299,3	2,14	382	2,66	479,2	3,28	562	3,8	652,5	4,36
301	2,15	382,8	2,67	480,6	3,29	565	3,81	655	4,37
303	2,16	384	2,68	482	3,3	566	3,82	656	4,38
304	2,17	386	2,69	485	3,31	568	3,83	658	4,39
307	2,19	387	2,7	486	3,32	569	3,84	658,88	4,4
309	2,2	388,8	2,71	487	3,33	570	3,85	660,4	4,41
310,5	2,21	391	2,72	489	3,34	572	3,86	662	4,42
312	2,22	392	2,73	490	3,35	573,6	3,87	664	4,43
314	2,23	394	2,74	492	3,36	575	3,88	666	4,44
314,83	2,24	395	2,75	494	3,37	577	3,89	670	4,47
316,87	2,25	397	2,76	495	3,38	579	3,9	672,67	4,48
318	2,26	398	2,77	497	3,39	580	3,91	674	4,49
320	2,27	400	2,78	498,94	3,4	582	3,92	675	4,5
323,2	2,29	401,4	2,79	500	3,41	584	3,93	680	4,53
324,7	2,3	404	2,8	502	3,42	585	3,94	685	4,56
326	2,31	405	2,81	503	3,43	588	3,96	705	4,68
328	2,32	406	2,82	505	3,44	590	3,97	745	4,93
329,2	2,33	408	2,83	506	3,45	592	3,98	750	4,96
331	2,34	409	2,84	508	3,46	593,3	3,99	753	4,98
332	2,35	412	2,85	509,4	3,47	595	4	756	4,99
334	2,36	413	2,86	511	3,48	598,5	4,02	760	5,02
335,6	2,37	413,73	2,87	512,8	3,49	600	4,03	761	5,03
338	2,38	417	2,89	514	3,5	602	4,04	763	5,04

## 2. FEP SEAL

### a) Definition

The FEP seal has a square or round shaped cross section with an elastomer core and a FEP or PFA jacket. It combines the flexibility of the elastomer with the chemical resistance of fluoropolymer.

### b) Characteristics

#### ✓ Material

##### FEP JACKET

FEP is the abbreviation for tetrafluoroethylene – hexafluoropropylene. This material is similar to PTFE and it offers, however, a better mouldability, making it possible to produce thin jackets for FEP seals.

##### ELASTOMER CORE

The thermoplastic FEP jacket is a semi-rigid material. The elastomer core restores the elasticity of the seal. There are two different elastomer cores to choose from:

- FKM, -20°C to 200°C
- MVQ (silicone), -60°C to +200°C

This information is on a guidance basis only. Do not tend simultaneously to both extremes of the temperature range.

#### ✓ Mounting & applications

A FEP seal is mounted instead of a standard O-Ring. The sizing of the grooves will be the same as for an O-Ring (see page 68). However, during installation, extending, pulling, on the seal should be avoided, because the FEP jacket will be subject to plastic deformation. Mounting in an open groove is recommended.

##### APPLICATIONS

- Chemical sectors
- Petroleum industries
- Medical and pharmaceutical sectors
- Climate control systems
- Food applications
- Paint and dyes applications.



#### ✓ Profiles

Full core  
Standard



Hollow core  
On request



Square cross-section  
On request



rectangular  
cross-section  
On request

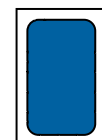

### 3. PRECISION O-RING

#### a) Definition

Techné's precision O-Ring is a specific seal made to meet the high quality requirements of certain industry fields. For example: watchmaking, microelectronics, or medical applications. The cross section S must not exceed 2mm.

#### b) Characteristics

Precision O-Rings must be asked specifically. This will not only able Techné to develop adapted seals, but also to help groove design. This will ensure a quality sealing.



A watch seal

#### ✓ Materials

Techné precision O-Rings are available with the same materials, certifications as standard Techné O-Rings (see page 66). Upon request, a specific material can be developed in order to meet customer demands.

#### ✓ Manufacturing and inspection

Techné precision O-Rings are obtained by compression moulding only. For aspect quality, Techné refers itself to the ISO 3601-3:2008 Grade S. For dimensions, Techné applies its own tolerances.

#### TOLERANCES INTERNAL Ø d

Ø d <	3.5	12	20	32	≥32
Tolerances ±	0.06	0.09	0.1	0.12	0.15

On request, Techné supplies precision seals according to customer drawing.

#### TOLERANCES ON CROSS-SECTION Ø S

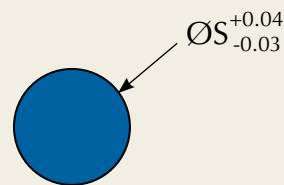

watch glass seal

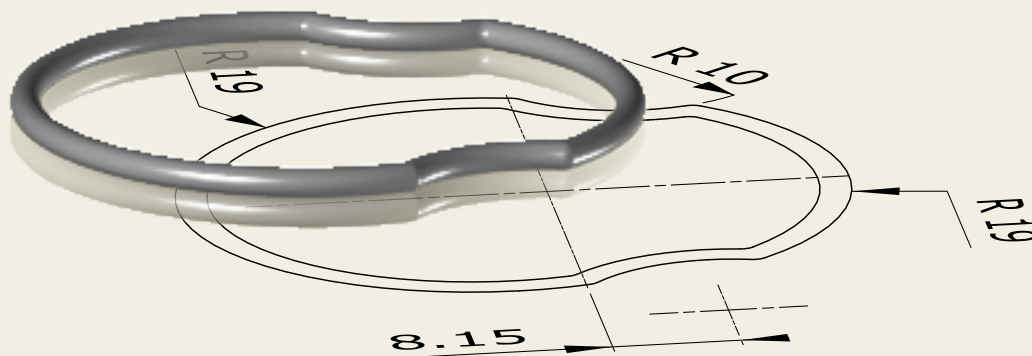

# 4. TECHNICAL INSTRUCTIONS

## a) Standard groove sizing

To ensure a good sealing, Techné O-Ring must go through a deformation force when mounted in its groove. The pressure of the sealed fluid adds stress on the seal and energises it. In order to guarantee the sealing, the housing (grooves) must follow certain rules, that are given below. (For standard housing see ISO 3601-2:2008).

### ✓ Decision tree for the choice of the groove

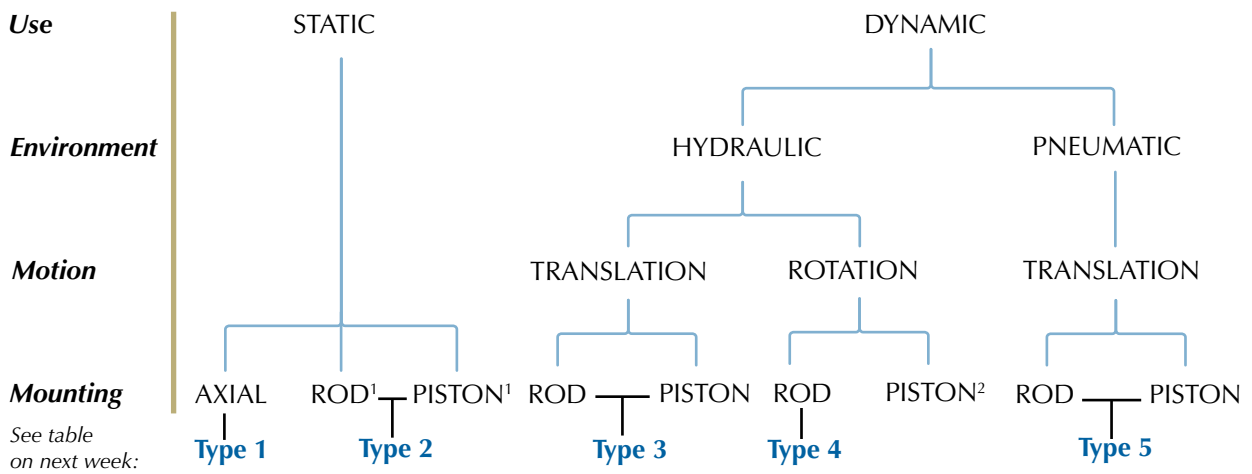

1 Depending on the available space, rod mounting is recommended. The gap behind the seal will not increase under pressure.  
 2 Avoid this mounting, because the seal will twist.

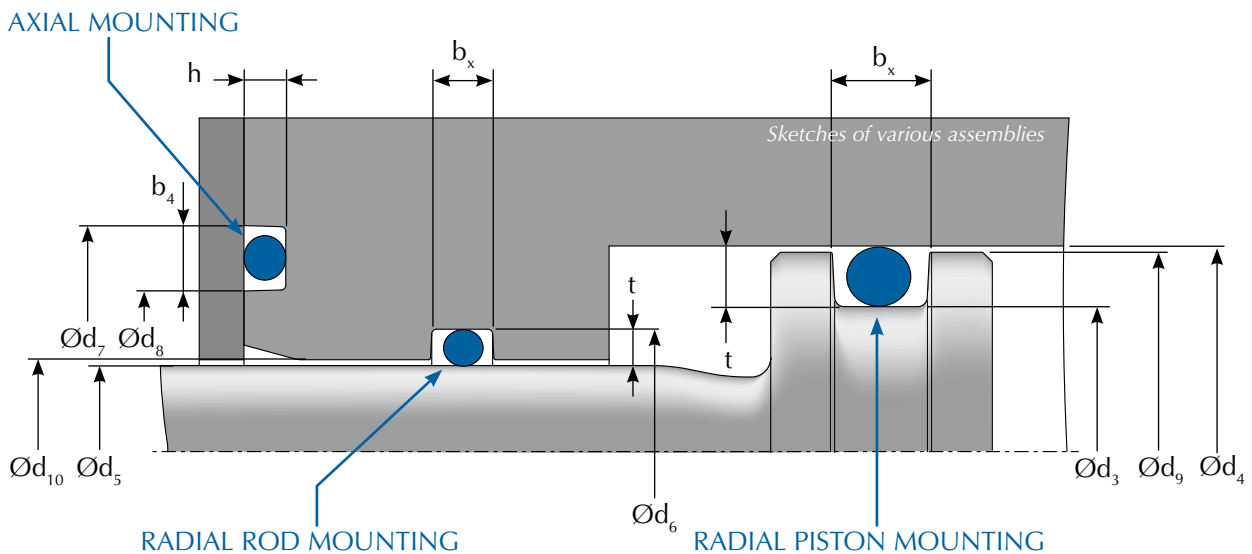

Sides taper of groove : 0 to 5°  
 For radii and chamfers, see page 75

### ✓ Size table for groove section & height

$h$  : groove section for axial mounting (see sketch on previous page)

$t$  : groove section for radial rod or piston mounting

$b_x$  : groove section for axial mounting

$b_x$  : groove height for radial mounting, the index  $x$  changes according to the number of backup rings (BAE).

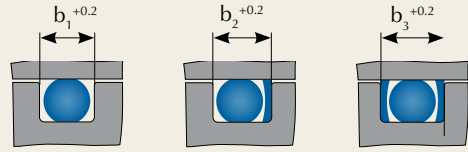

	Groove section					Groove width			
	Type 1	Type 2	Type 3	Type 4	Type 5	Type 1	Type 2, 3, 4 & 5		
	Static Axial	Static Rod or piston	Hydraulic Reciprocating Rod or piston	Hydraulic Rotation Rod	Pneumatic Reciprocating Rod or piston	Static Axial	Rod or piston		
	$h$	$t$	$t$	$t$	$t$	$b_4$	$b_1$	$b_2$	$b_3$
1,00	0,80	0,80	0,80	0,90	0,80	1,30	1,30	2,70	4,10
1,20	0,90	1,00	1,00	1,10	1,00	1,60	1,50	2,90	4,30
1,40	1,10	1,20	1,20	1,30	1,20	1,80	1,70	3,10	4,50
1,50	1,10	1,10	1,30	1,40	1,30	2,10	1,80	3,20	4,60
1,60	1,20	1,20	1,40	1,40	1,40	2,20	1,90	3,30	4,70
1,78	1,30	1,40	1,50	1,60	1,50	2,50	2,20	3,60	5,00
1,80	1,40	1,30	1,50	1,60	1,50	2,40	2,20	3,60	5,00
1,90	1,40	1,40	1,60	1,70	1,60	2,60	2,30	3,70	5,10
2,00	1,50	1,50	1,80	1,80	1,80	2,70	2,30	3,70	5,10
2,40	1,80	1,80	2,10	2,20	2,20	3,30	2,80	4,20	5,60
2,50	1,90	1,90	2,20	2,30	2,30	3,40	2,90	4,30	5,70
2,62	2,00	2,00	2,30	2,40	2,40	3,50	3,00	4,40	5,80
2,65	2,00	2,00	2,30	2,40	2,40	3,60	3,10	4,50	5,90
2,70	2,00	2,00	2,40	2,40	2,50	3,70	3,10	4,50	5,90
3,00	2,30	2,30	2,60	2,80	2,80	4,00	3,50	4,90	6,30
3,10	2,30	2,40	2,70	2,90	2,90	4,30	3,60	5,00	6,40
3,50	2,70	2,70	3,10	3,20	3,20	4,60	4,00	5,40	6,80
3,53	2,80	2,70	3,10	3,20	3,30	4,50	4,10	5,50	6,90
3,55	2,80	2,70	3,10	3,30	3,30	4,60	4,20	5,60	7,00
3,60	2,80	2,70	3,20	3,30	3,30	4,70	4,10	5,50	6,90
4,00	3,10	3,10	3,50	3,70	3,70	5,30	4,70	6,10	7,50
4,50	3,50	3,50	4,00	4,10	4,20	5,90	5,20	6,60	8,00
5,00	3,90	3,90	4,40	4,60	4,70	6,50	5,80	7,20	8,60
5,33	4,20	4,10	4,70	4,90	5,00	6,90	6,20	8,00	9,80
5,50	4,30	4,30	4,90	5,10	5,10	7,20	6,30	8,10	9,90
5,70	4,40	4,50	5,00	5,30	5,30	7,50	6,60	8,40	10,20
6,00	4,70	4,70	5,30	5,60	5,60	7,80	6,90	8,70	10,50
6,99	5,50	5,50	6,20	6,50	6,60	9,10	8,00	10,60	13,20
8,00	6,30	6,30	7,10	7,40	7,60	10,40	9,20	11,80	14,40
8,40	6,60	6,90	7,50	7,80	7,90	10,90	9,60	12,20	14,80
10,00	7,90	8,00	8,90	9,30	9,50	12,90	11,50	14,10	16,70
12,00	9,50	9,50	10,70	11,30	11,40	15,50	13,70	16,30	18,90
14,00	11,10	11,90	12,60	13,20	13,30	18,00	15,90	18,50	21,10
16,00	12,60	13,50	14,50	15,00	15,20	20,70	18,00	20,60	23,20
18,00	14,20	15,00	16,40	16,90	17,10	23,30	20,20	22,80	25,40
20,00	15,80	17,00	18,40	18,80	19,10	25,80	22,20	24,80	27,40

## ✓ Static axial mounting (Type 1)

### APPLICATIONS

To seal lids, casings or flanges, it is common to use an axis mounted O-Ring. To determine the optimal size of the housings, it is important to take into account the pressure direction.

### EXTERNAL PRESSURE

When the pressure comes from outside, the inside diameter ( $d$ ) of the O-Ring must match the diameter of the groove ( $d_8$ ), or be a little smaller in order to avoid seal movements.

### INTERNAL PRESSURE

When the pressure comes from the inside, the outer diameter ( $d + 2 \times S$ ) of the O-Ring must match the outside diameter of the groove ( $d_7$ ), or even be a little bigger in order to avoid seal movements.

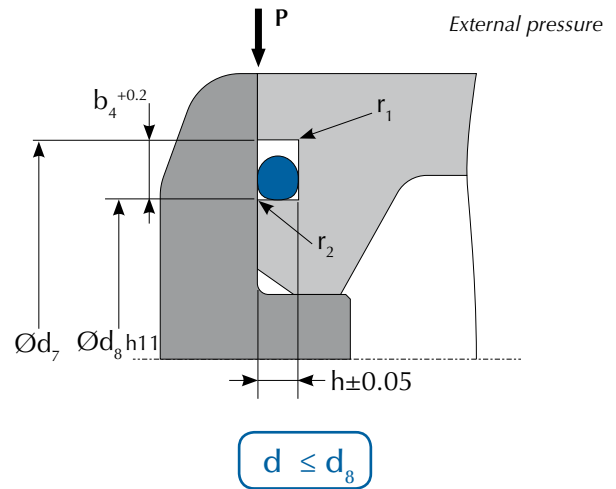

### Roughness

Unit : $\mu\text{m}$	$R_{\text{maxi}}$	Rz	Ra
Sealing surface	$\leq 16$	$\leq 6.3$	$\leq 1.6$
Groove base	$\leq 16$	$\leq 6.3$	$\leq 1.6$
Groove side	$\leq 25$	$\leq 6.3$	$\leq 1.6$

For pulsating pressures (O-Ring hardness of 80 IRHD), use a Ra 0.8 for the sealing surface, and a R2 1.2 for other surfaces.

Avoid all sharp edges. For bottom groove radius  $r_1$ , and groove edges  $r_2$ , see page 75.

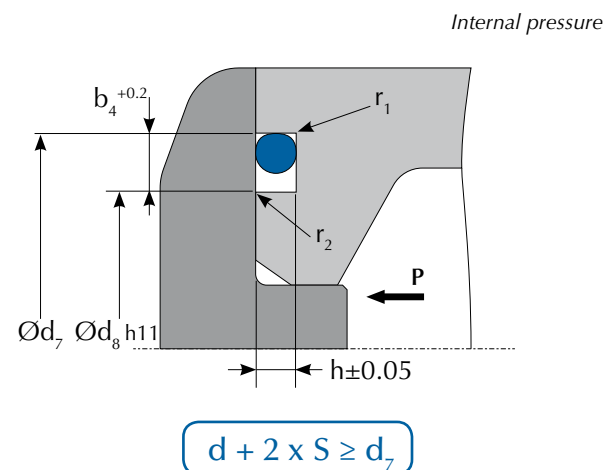



## ✓ Static radial mounting (Type 2)

### APPLICATIONS

This type of mounting is used to seal lids or cases that require centering. Rod or piston sealing, will depend on the amount of available space in the assembly. But to seal the bottom of a cylinder it is recommended to use a rod hollow lid.

The inside diameter (d) of the O-Ring must go through a deformation force when mounted in its groove. See formula shown against.

### ROUGHNESS

Unit : $\mu\text{m}$	$R_{\text{maxi}}$	Rz	Ra
Sealing surface	$\leq 16$	$\leq 6.3$	$\leq 1.6$
Groove base	$\leq 16$	$\leq 6.3$	$\leq 1.6$
Groove side	$\leq 25$	$\leq 6.3$	$\leq 1.6$

For pulsating pressures (O-Ring hardness of 80 IRHD), use a Ra 0.8 for the sealing surface, and a Ra 1.6 for other surfaces.

Avoid all sharp edges. For bottom groove radius r1, groove edges r2, and chamfer z, see page 75.

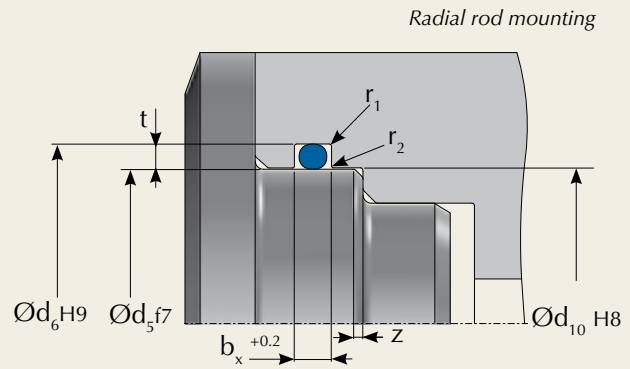

$$d + 2 \times S = d_6 / 0.97 \pm 0.02$$

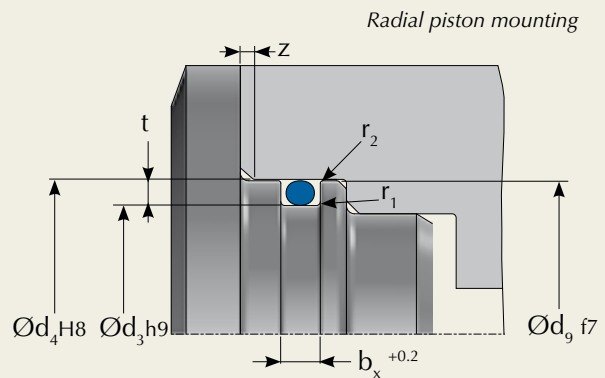

$$d = d_3 / 1.03 \pm 0.02$$

## ✓ Hydraulic- Radial mounting for translation (Type 3)

### APPLICATIONS

Techné O-Rings can be used in hydraulic systems that are subject to translation movements. The efficiency of this sealing solution is not so good, but has the advantages of being compact, and therefore does not take up a lot of space. It is recommended to use hydraulic seals. See Techné catalogue, *Hydraulic seals*.

Speed Limit : 0.5 m.s<sup>-1</sup>

### ROUGHNESS

Unit : $\mu\text{m}$	R <sub>maxi</sub>	Rz	Ra
Sealing surface	≤ 2	0.63-1.6	0.1-0.4
Groove base	≤ 6	≤ 6.3	≤ 1.6
Groove side	≤ 25	≤ 6.3	≤ 1.6

Avoid all sharp edges. For radius of bottom groove radius r1, groove edges r2, and chamfer z, see page 75.

To know the allowed gap between the elements that need to be sealed, see diagram on page 84.

**It is important to remember that from 50 bars pressure, is recommended to use a Back Up ring.**

To ensure a good pressure resistance Techné recommends:

Pressure	O-Ring hardness
P ≤ 60 bar	70 IRHD
P > 60 bar	90 IRHD

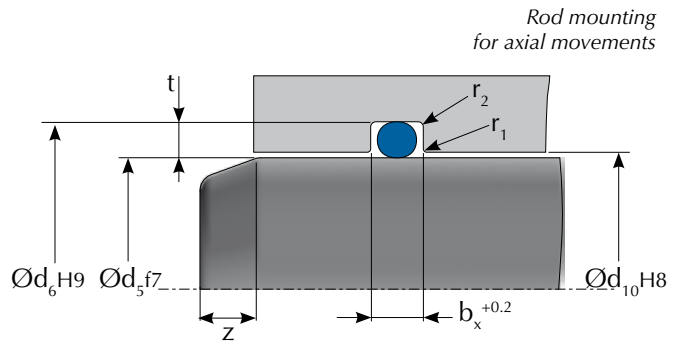

$$d + 2 \times S = d_6 / 0.95 \pm 0.01$$

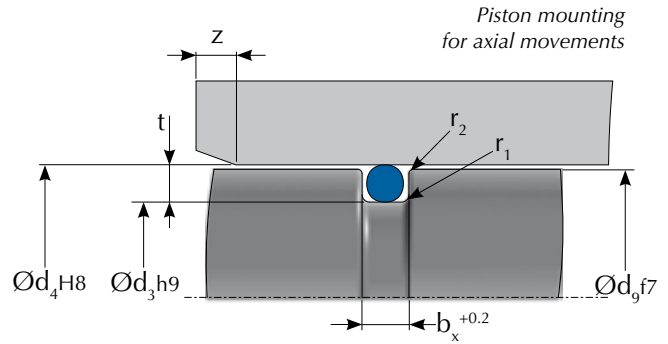

$$d = d_3 / 1.05 \pm 0.01$$

### ✓ Hydraulic- Radial mounting for rotation (Type 4)

#### APPLICATIONS

Techné O-Ring can be used in rotating applications, if space is limited and not subject to high constraints. However it preferable to use sealing rings (see Techné's catalogue, *Rotary seals*).

Techné O-Rings are to be installed in the static housing part.

**Speed limit : 4 m.s<sup>-1</sup>**

#### ROUGHNESS

Unit : $\mu\text{m}$	$R_{\text{maxi}}$	$R_z$	$R_a$
Sealing surface	$\leq 2$	0.63-1.6	0.1-0.4
Groove base	$\leq 6$	$\leq 6.3$	$\leq 1.6$
Groove side	$\leq 25$	$\leq 6.3$	$\leq 1.6$

Avoid all sharp edges. For radius of bottom groove radius  $r_1$ , groove edges  $r_2$ , and chamfer  $z$ , see page 75.

The housing must have a hardness of 60 HRC. It is therefore recommended to avoid using plastics, or certain metals (such as brass, bronze, etc.) for the shaft.

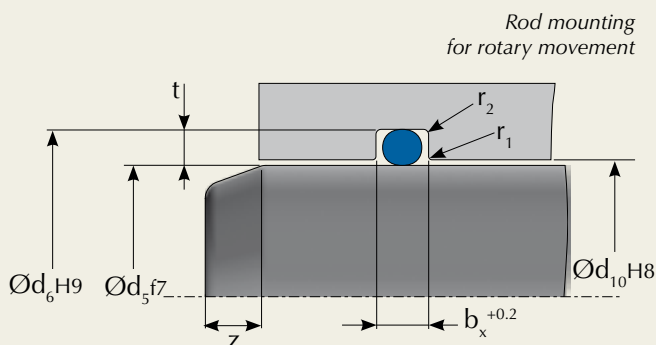

$$d + 2 \times S = d_6 / 0.97 \pm 0.02$$

For some cases, the piston mounting can't be avoided. Prefer a J74 and set value :  
 $d = d_3 / 1.03 \pm 0.01$

### ✓ Pneumatic - radial mounting for translation (Type 5)

#### APPLICATIONS

In specific applications, Techné O-Rings can also be used in pneumatic systems.

**Speed limit 0.5 m.s<sup>-1</sup>**

#### ROUGHNESS

Unit : $\mu\text{m}$	$R_{\text{maxi}}$	$R_z$	$R_a$
Sealing surface	$\leq 2$	0.63-1.6	0.1-0.4
Groove base	$\leq 6$	$\leq 6.3$	$\leq 1.6$
Groove side	$\leq 25$	$\leq 6.3$	$\leq 1.6$

Avoid all sharp edges. For radius of bottom groove radius  $r_1$ , groove edges  $r_2$ , and chamfer  $z$ , see page 75.

To improve sliding properties, see the T-coat coating page 50.

For a float mounted fitting, see next page.

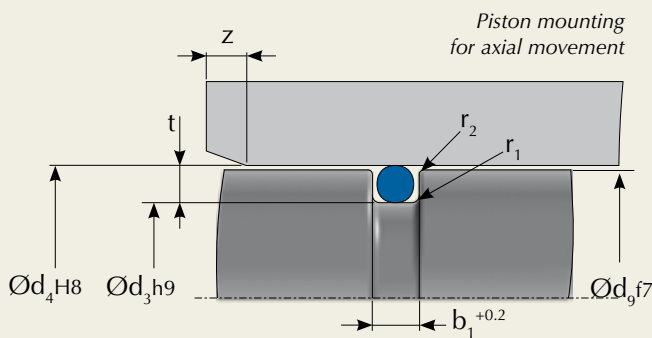

$$d = d_3 / 1.02 \pm 0.01$$

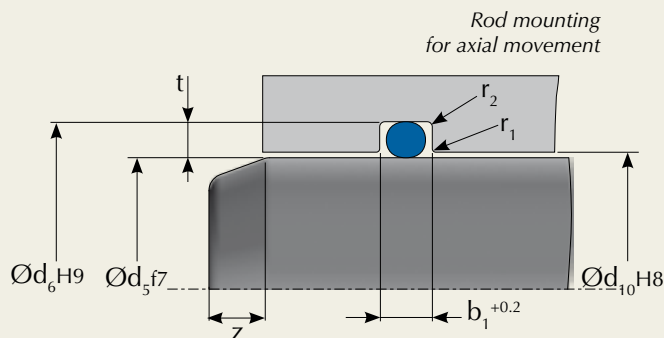

$$d + 2 \times S = d_6 / 0.98 \pm 0.01$$

## b) Specific groove

### ✓ Pneumatic - floating assembly for piston

Pneumatic sealing is difficult to make with an O-Ring because of: compression problems, stick-slip effect, lack of lubrication, etc. So it is possible to float-mount the seal. In such case, the following rules must be considered:

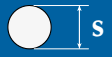
 s	t	b <sub>1</sub>
1.78	2.1	2.1
1.80	2.1	2.1
2.40	2.7	2.8
2.62	3.0	3.0
2.65	3.0	3.1
3.00	3.4	3.5
3.53	4.0	4.0
3.55	4.0	4.0
5.30	6.0	6.0
5.33	6.0	6.1
5.70	6.4	6.5
6.99	7.9	7.9
7.00	7.9	7.9

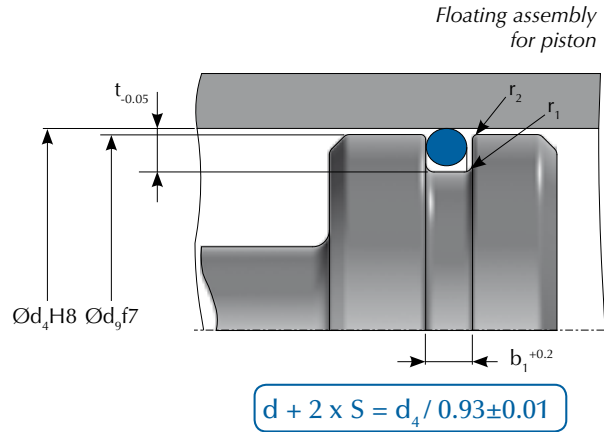

Techné O-Rings must not touch the bottom of the groove. When the system is under pressure, an air flow will pull out until the seal becomes energised thus increasing the quality of the sealing.

### ✓ Trapezoidal groove

When the O-Ring must be held firmly in the housing groove it is possible to use a trapezoidal groove. However, due the difficult manufacture of the trapezoidal groove, we recommend to use, for all future conceptions a rectangular groove.

 t	b <sub>1</sub>	r <sub>1</sub>	r <sub>2</sub>	
3.53	2.9±0.07	3.1	0.6	0.2
3.55	2.9±0.07	3.1	0.6	0.2
4.00	3.3±0.08	3.5	0.7	0.2
4.50	3.7±0.09	4.0	0.7	0.3
5.00	4.1±0.10	4.4	0.8	0.3
5.30	4.4±0.11	4.7	0.9	0.3
5.33	4.4±0.11	4.7	0.9	0.3
5.50	4.5±0.11	4.8	0.9	0.3
5.70	4.7±0.11	5.0	0.9	0.3
6.00	5.0±0.12	5.5	1.0	0.4
6.50	5.4±0.13	5.9	1.1	0.4
7.00	5.8±0.14	6.3	1.2	0.4
7.50	6.2±0.15	6.7	1.2	0.4
8.00	6.7±0.16	7.3	1.3	0.5
8.40	7.1±0.17	7.9	1.3	0.5
8.50	7.2±0.17	8.0	1.4	0.5
9.00	7.5±0.18	8.1	1.5	0.5
9.50	7.9±0.19	8.6	1.6	0.6
10.00	8.3±0.20	9.0	1.7	0.6

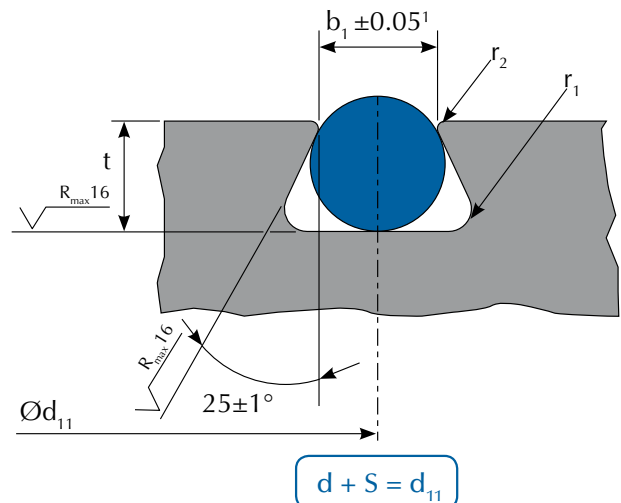

<sup>1</sup> b<sub>1</sub> = housing width, corresponds to the tangent to the r<sub>2</sub> radius

## ✓ Chamfers and radii

### GROOVE RADII

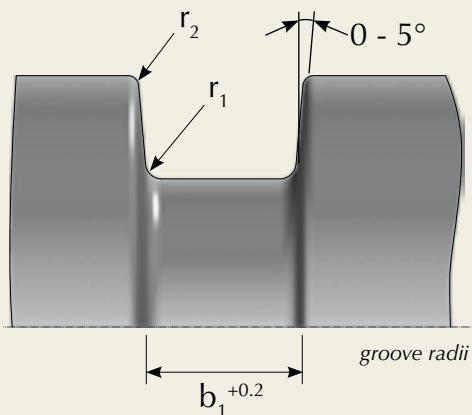

$b_1$	$r_1$	$r_2$
$\leq 3$	0.25	0.1
$> 3$	0.50	0.2

### CHAMFERS FOR ROD AND TUBE

 s	z (mini)
$\leq 1.5$	1
1.50	1.2
1.78	1.5
1.80	1.6
2.00	1.7
2.40	1.7
2.50	1.7
2.62	1.8
2.65	1.9
3.00	2.1
3.53	2.3
4.00	2.7
4.50	3.1
5.00	3.1
5.33	3.4
5.50	3.6
5.70	3.6
6.00	3.7
6.50	4.1
6.99	4.1
7.50	4.6
8.00	4.6
8.50	5.1
9.50	5.5
10.00	5.9
$> 10$	$S \times 0.6$

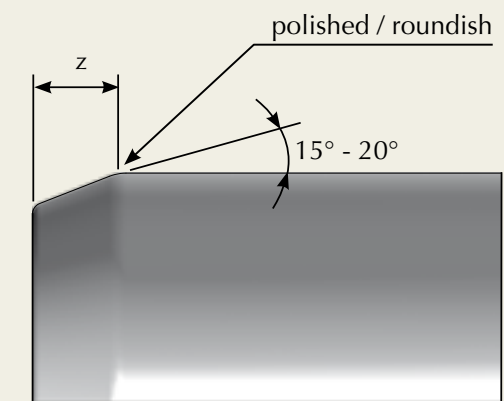
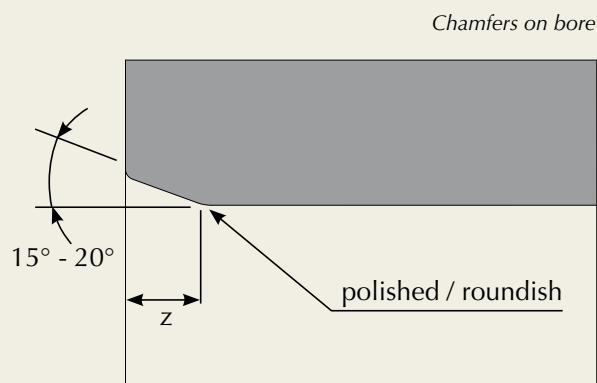

## c) Mounting instructions

Before mounting Techné O-Rings, the shaft and the housing must be cleaned and without any burr that might damage the seal.

If, when mounting, the seal must go over a thread or a keyway, the use of a mounting jig is recommended.

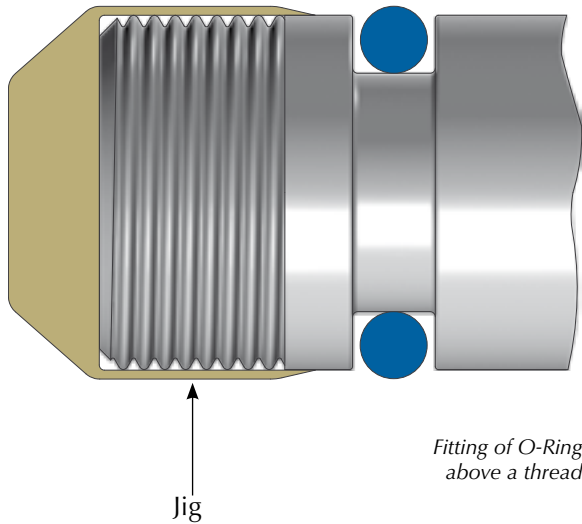

Seals must not be twisted when mounted. Elongation of a short duration is possible; however, it is important to avoid any elongation over 100% and to allow time for the seal to regain its original shape. The smaller the shaft is, the attention must be paid to the elongation percentage.

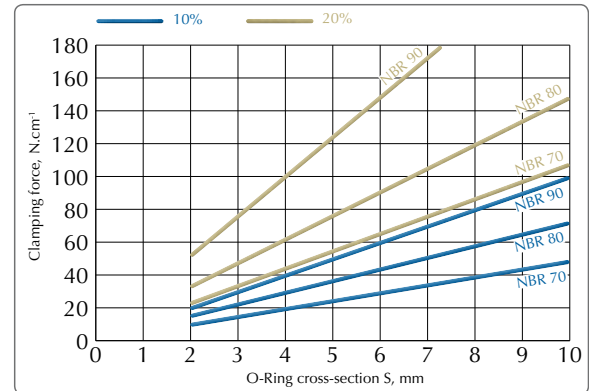

Clamping force required for a compression on the o-ring cross-section equal to 10% and 20% (Indicative Values)

O-Rings 62 

## JT4 X-Rings

78



Backup Rings (BAE) 84 

Rubber Cord 94 

JR Fitting Seals 96 

Bonded Seals 100 

Triclover Clamp Seals 108 

O-Ring Seals 114 

SMS Seals 118 

Macon Seals 122

Aseptic O-Rings DIN 11864 126

# 1. JT4 X-RINGS

## a) Definition

78



The JT4 is a four lobed double acting seal. Thanks to its symmetrical shape, it is energised by the pressure which increases the quality of the sealing. The shape of the JT4 seal is similar to 4 tangent O-rings. The outside dimensions of the JT4 are defined in the same way as the O-ring:

$\text{Ød} \times \text{S}$

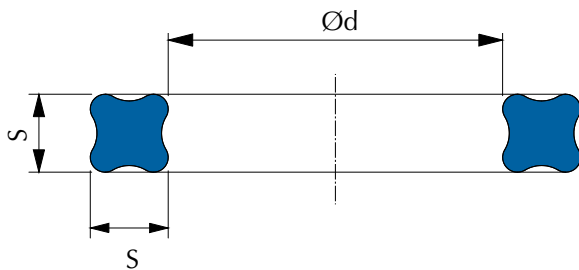

The AS 568 is the standard dimensional standard. The JT4 can be mounted instead of an O-ring, to know more about these mountings please see page 80.

## b) Characteristics

### ✓ Advantages

The JT4 were designed as an alternative to O-rings. Contrary to O-rings JT4 are not affected by rolling or twisting, this is a great advantage in translation or dynamic systems, it is also useful during assembly.

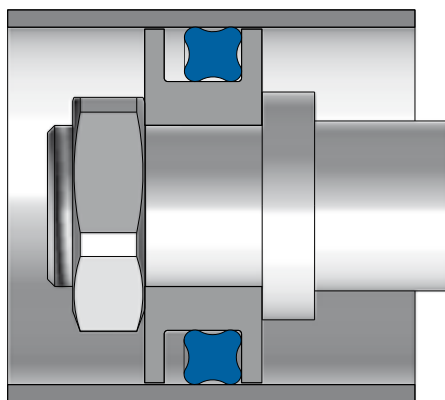

*JT4 stays in position*

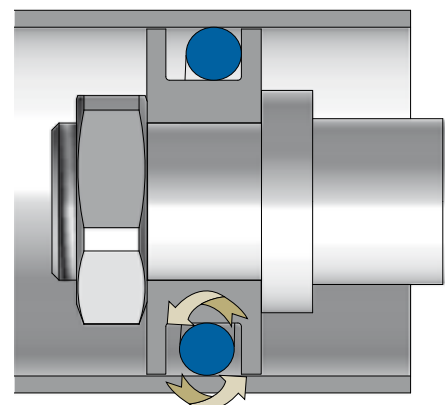
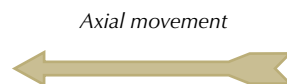

*The O-ring twists*



Thanks to its four lobes the JT4 has double sealing properties. The required tightening is reduced, its load is distributed throughout the seal, and it is more stable. A small amount of grease is held in between the lips, so that the life time of the seal is increased.

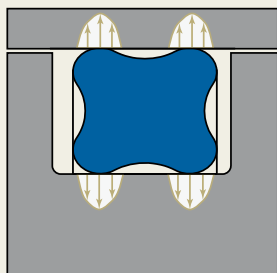

Balanced distribution of mounting stresses on the JT4

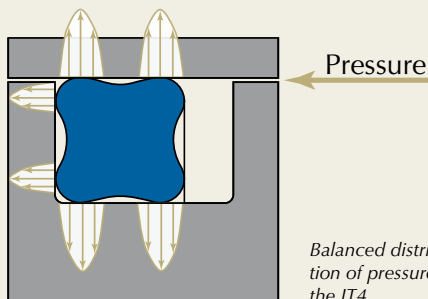

Balanced distribution of pressure on the JT4

### ✓ Limits

#### PRESSURE

Static sealing :

- 50 bar without BAE (Back-up Ring, see page 84)
- 400 bar with BAE

Sealing with axial motion:

- 50 bar without BAE
- 300 bar with BAE

Sealing with rotary motion:

- 150 bar with BAE.

#### SPEED

Sealing with axial motion:

- 0.5 m.s<sup>-1</sup>

Sealing with rotary motion:

- 2 m.s<sup>-1</sup>

For high constraint translation applications, see Techné catalogue, *Hydraulic seals* and for rotary application see Techné catalogue, *Rotary seals*.

### ✓ Material

	70 IRHD	80 IRHD	90 IRHD
NBR	01.0600	01.0601	01.0602
NBR + MoS <sub>2</sub>	01.0604	1	1
FKM	01.0650	01.0651	1
HNBR	01.0610	1	1
EPDM	01.0670	1	1
Silicone	01.0660	1	1

<sup>1</sup>On request

Other colours than black can be delivered. It is also possible to apply a surface treatment, for more information see page 50.

### ✓ Dimensions & Tolerances

ADVISABLE TOLERANCES FOR THE JT4 CROSS-SECTION S ACCORDING TO AS568:

S	≤1.78	2.62	3.53	5.33	6.99
±	0.08	0.08	0.1	0.13	0.15

ADVISABLE TOLERANCES FOR THE JT4 INTERNAL DIAMETER D :

<b>S ≤ 1.78 ± 0.08</b>		
<b>d ≤</b>	<b>NBR ±</b>	<b>other ±</b>
1.5	0.10	0.15
13	0.13	0.15
15	0.18	0.23
24	0.23	0.25
29	0.25	0.28
34	0.28	0.33
50	0.33	0.46
64	0.46	0.51
74	0.51	0.61
94	0.61	0.69
104	0.69	0.76
124	0.76	0.94
134	0.94	1.02

<b>S = 3.53 ± 0.10</b>		
<b>d ≤</b>	<b>NBR ±</b>	<b>other ±</b>
13	0.13	0.18
15	0.18	0.23
18	0.23	0.25
27	0.25	0.30
37	0.30	0.38
45	0.38	0.46
54	0.46	0.51
67	0.51	0.61
89	0.61	0.71
105	0.71	0.76
121	0.76	0.84
130	0.84	0.89
152	0.89	1.02
178	1.02	1.14
203	1.14	1.27
229	1.27	1.40
267	1.40	1.65
381	1.65	1.90
406	1.90	2.16
431	2.16	2.42
457	2.42	2.55

<b>S = 2.62 ± 0.08</b>		
<b>d ≤</b>	<b>NBR ±</b>	<b>other ±</b>
2.1	0.10	0.13
13	0.13	0.18
15	0.18	0.23
20	0.23	0.25
29	0.25	0.30
39	0.30	0.38
48	0.38	0.43
58	0.43	0.51
67	0.51	0.56
75	0.56	0.61
94	0.61	0.71
102	0.71	0.76
122	0.76	0.89
153	0.89	1.02
178	1.02	1.14
203	1.14	1.27
229	1.27	1.40
248	1.40	1.52

<b>S = 6.99 ± 0.15</b>		
<b>d ≤</b>	<b>NBR ±</b>	<b>other ±</b>
124	0.84	0.94
152	0.94	1.02
178	1.02	1.14
203	1.14	1.40
254	1.40	1.52
330	1.52	1.79
394	1.79	1.90
418	1.90	2.05
431	2.05	2.15
469	2.15	2.29
495	2.29	2.41
533	2.41	2.55
558	2.55	2.65
583	2.65	2.80
609	2.80	2.90
634	2.90	3.05
660	3.05	3.20

<b>S = 5.33 ± 0.13</b>		
<b>d ≤</b>	<b>NBR ±</b>	<b>other ±</b>
13	0.13	0.18
15	0.18	0.23
18	0.23	0.26
27	0.25	0.25
37	0.30	0.38
47	0.38	0.46
60	0.46	0.51
73	0.51	0.61
89	0.61	0.71
105	0.71	0.76
129	0.76	0.94
152	0.94	1.02
178	1.02	1.14
203	1.14	1.27
229	1.27	1.40
254	1.40	1.52
280	1.52	1.65
330	1.65	1.78
381	1.78	1.91
406	1.91	2.03
431	2.03	2.15
457	2.15	2.25
482	2.25	2.41
533	2.41	2.54
558	2.54	2.67
583	2.67	2.79
609	2.79	2.92
634	2.92	3.05
659	3.05	3.20

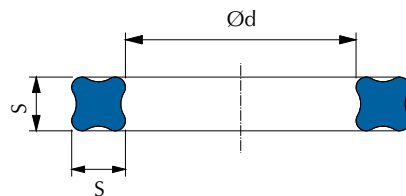

## 2. TECHNICAL INSTRUCTIONS



### a) Standard groove sizing

To ensure sealing, Techné JT4 must undergo a deformation force when mounted in its groove. The pressure of the sealed fluid will, in addition to the existing force, energise the seal. To guarantee a quality sealing the housing must follow certain rules, given below.

#### ✓ Decision tree for the choice of the groove

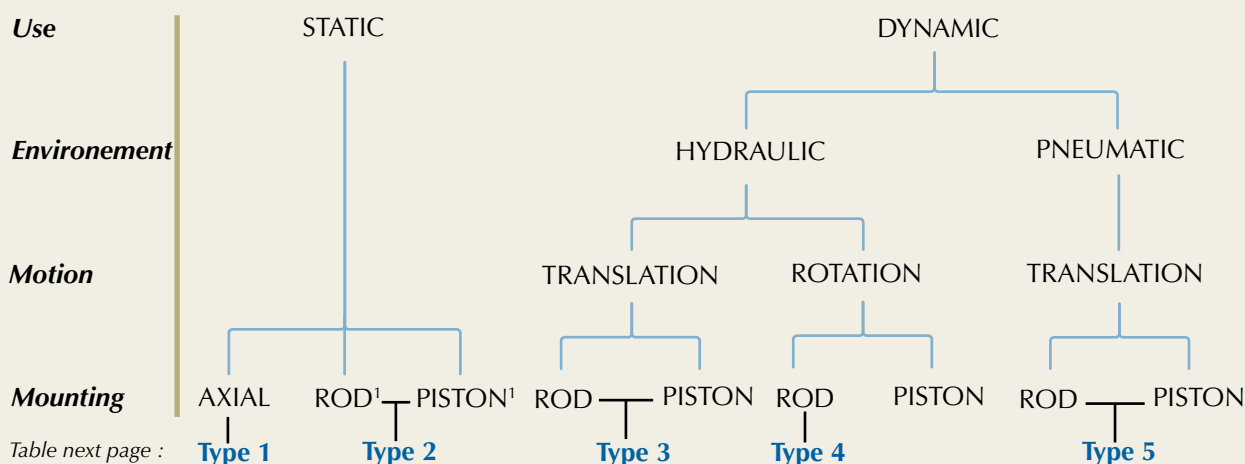

<sup>1</sup>Depends on bulkiness of the system. However prefer the rod mounting, especially for cylinder bases ; the clearance will not increase behind the seal, even if the tube expands with the pressure.

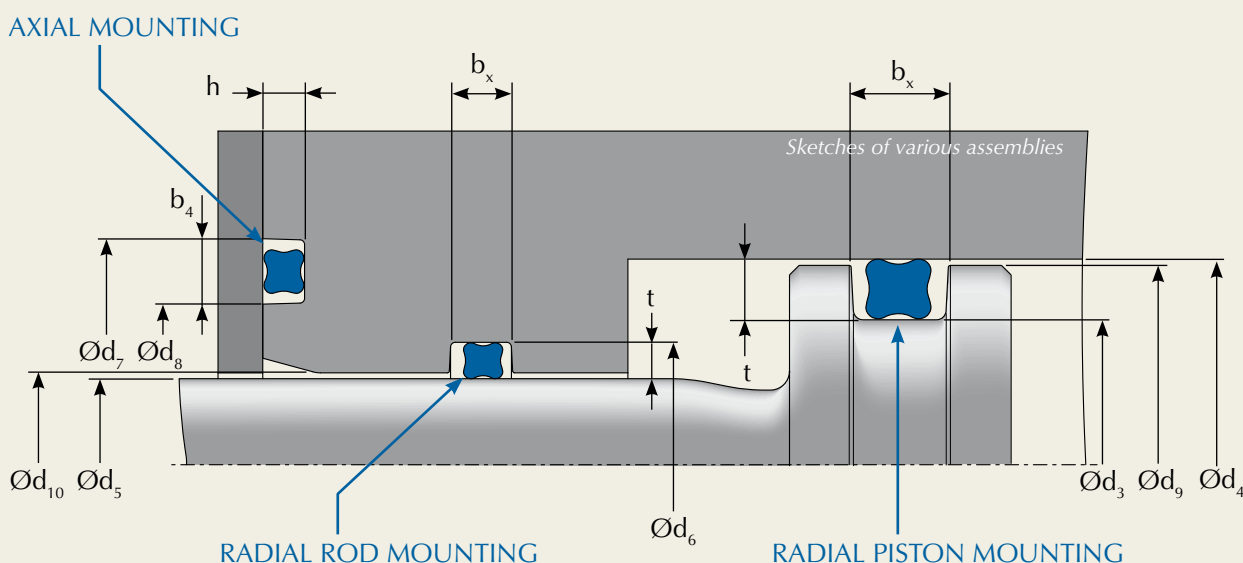

Sides taper of groove : 0 to 5°  
For the radii and chamfers, see page 75

## ✓ Table chart for height and section of the grooves for JT4

$h$  : groove section for axial mounting (see sketch on previous page)

$t$  : groove section for radial rod or piston mounting

$b_4$  : groove section for axial mounting

$b_x$  : groove height radial mounting, the index  $x$  change according to the number of backup rings (BAE)

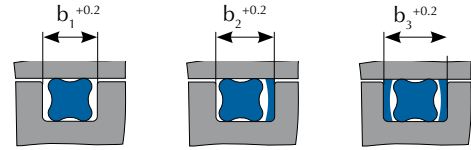

	Groove section					Groove height			
	Type 1	Type 2	Type 3	Type 4	Type 5	Type 1	Type 2, 3, 4 & 5		
	Static Axial	Static Rod or piston	Hydraulic Translation Rod or piston	Hydraulic Rotation Rod	Pneumatic Translation Rod or piston	Static Axial	Rod or piston		
	$h$	$t$	$t$	$t$	$t$	$b_4$	$b_1$	$b_2$	$b_3$
1,78	1,40	1,40	1,50	1,60	1,60	2,00	2,00	3,40	4,80
2,62	2,25	2,25	2,30	2,40	2,40	3,00	3,00	4,40	5,80
3,53	3,10	3,10	3,20	3,20	3,30	4,10	4,10	5,50	6,90
5,33	4,75	4,75	4,90	4,90	5,00	6,10	6,10	7,90	9,70
6,99	6,20	6,20	6,40	6,50	6,60	8,10	8,00	10,6	13,2

### JT4 SIZING

Apart of the dimension above, for the different mounting characteristics, please see the chapter on Techné O-rings, page 70.



O-Rings 62 

JT4 X-Rings 78 

## Backup Rings (BAE)

84



Rubber Cord 94 

JR Fitting Seals 96 

Bonded Seals 100 

Triclover Clamp Seals 108 

O-Ring Seals 114 

SMS Seals 118 

Macon Seals 122

Aseptic O-Rings DIN 11864 126

# 1. BACK-UP RINGS (BAE)

## a) Principle

### ✓ Extrusion

**E**xtrusion occurs when a part of the seal comes out of its groove and gets stuck in the space between the two parts that need sealing. This phenomenon causes the seal to deteriorate and this will compromise the sealing.

### ✓ Definition

Techné back-up rings are quick and simple to put into place. To avoid extrusion problems, place a back up ring on the side of the O-ring opposite to the pressure. When pressure is applied on both sides of the seal, insert two back up rings on either side.

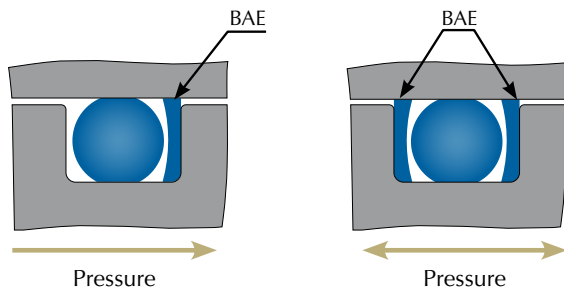
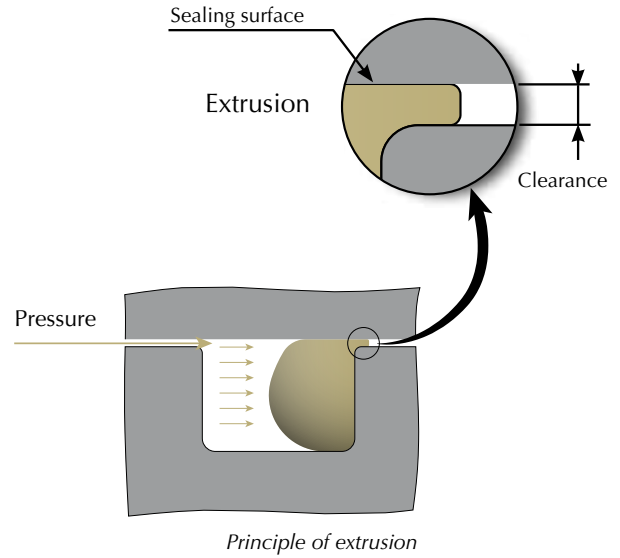

### Advantages

- O-ring life time increased
- Economic, low sealing cost, allows larger groove machining tolerances
- Pressure resistance better than O-rings. (recommended for applications with pressure higher than 50 bars).

### LIMITATIONS

Operating temperatures, and chemical resistance will determine the material used. The hardness of the seal will also be an important factor and should be chosen according to the application. Finally, the back-up ring must be chosen according to the pressure. See attached chart.

*Setting of BAE according to pressure*

*How to choose chart (static sealing)*

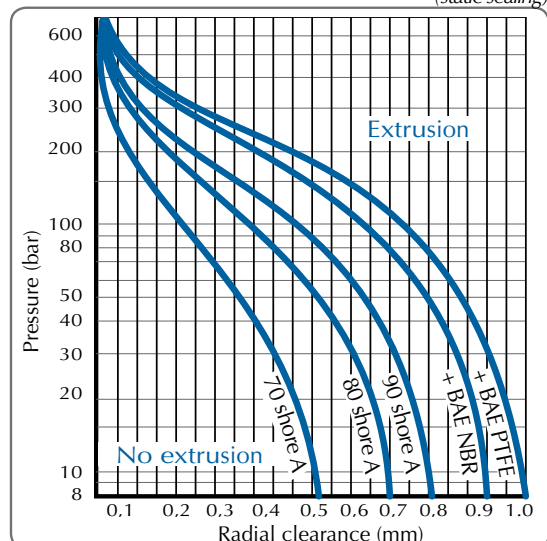

## b) Characteristics

### PROFILES

Five different profiles are defined by the ISO 3601-4:2008.

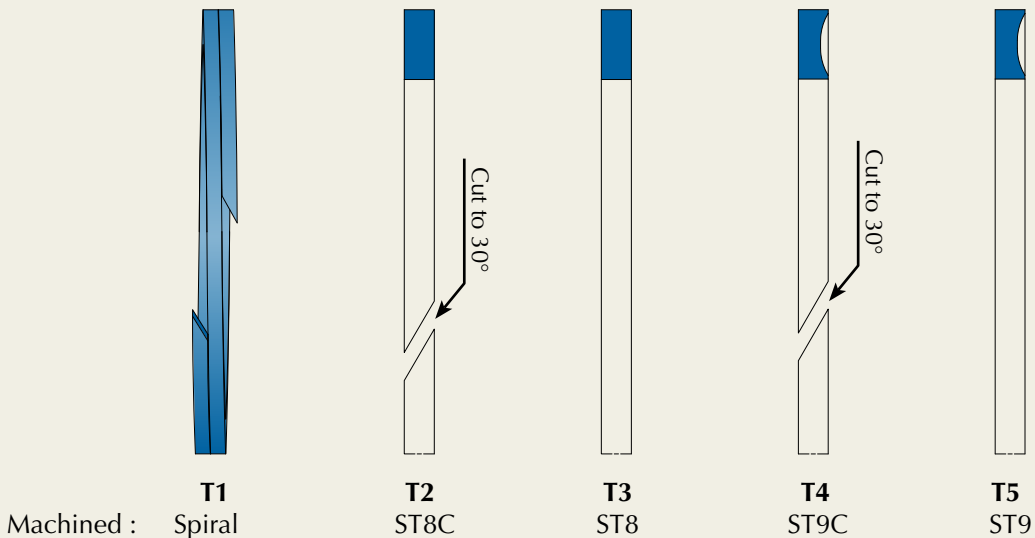

### ✓ Material

Depending on the application, the chemical environment and the pressure in contact with the back-up ring, Techné will suggest different materials:

#### ELASTOMER MATERIAL (FOR T2, T3, T4 & T5 PROFILES)

- NBR 90 IRHD
- FKM 90 IRHD
- HNBR 90 IRHD.

For more information about these materials, see page 35.

#### TPE (FOR T2, T3, T4 & T5 PROFILES)

- PU 95 IRHD

For more information about these materials, see page 40.

#### PLASTICS (FOR T1, T2 & T3 PROFILES)

- Virgin PTFE
- PTFE filled with carbon/graphite
- PTFE filled with Bronze
- PTFE filled with graphite
- POM
- PA.

### ✓ Manufacturing process

Elastomer back-up rings are usually moulded, but for short delays, Techné can offer machined back-up rings. All plastic back-up rings are machined by Techné.

### c) Dimensions

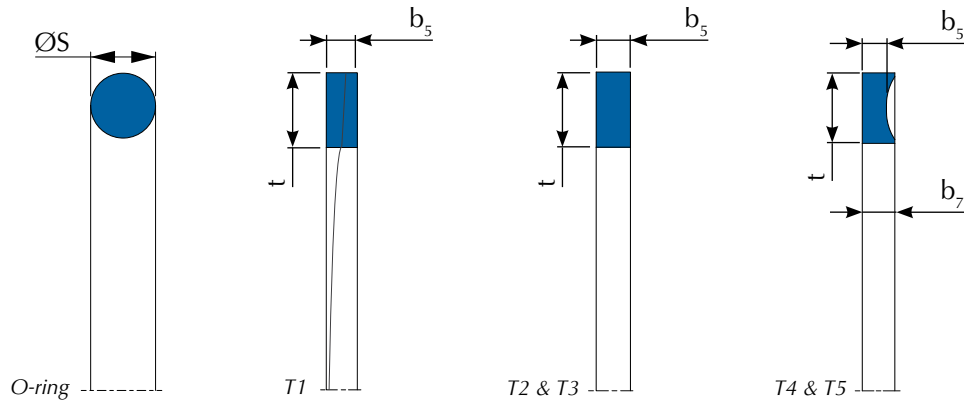

86

#### ISO 3601-4:2008

For ISO 3601-4:2008 normalised housings, Techné suggests the following back-up rings dimensions:

BAE	O-ring cross-section S				
	1.78	2.62	3.53	5.33	6.99
$b_5$	1.4	1.4	1.4	1.8	2.6
$b_7$	1.7	1.8	2.0	2.8	4.1
$t$	Housing cross-section				

To know more about housing dimensions, see the ISO 3601-2: 2008.

#### DIMENSIONS STANDARDS

For standard housings, Techné suggests the following back-up rings dimensions:

BAE	O-ring cross-section S	O-ring cross-section S				
		1.78	2.62	3.53	5.33	6.99
T1	$b_5$	1.4	1.4	1.4	1.7	2.5
T2	$t$	1.35	2.18	3	4.65	5.99
T3	$t$	1.35	2.18	3	4.65	5.99
T4 T5	$b_5$	1.14	1.14	1.02	1.52	2.44
	$b_7$	1.24	1.35	1.27	1.93	2.97
	$t$	1.35	2.18	3	4.65	5.99



### DIMENSIONAL TABLE FOR BACK-UP RINGS DEPENDING ON O-RING SIZE

For housings referring to ISO 3601 2 : 2008, the outside and inside diameters are defined. Thus the dimensions of the housing correspond to the back-up ring's dimension.

Regarding standards, only the inside diameter of the back-up ring is given. The cross section of the back-up ring varies with the cross section of the O-ring (see table on previous page).

O-ring		BAE		
 1.78		ISO 3601-2:2008		Standard
Or ref.	ID	ID	OD	ID
004	1,78	1,93	4,52	2,44
005	2,57	2,72	5,31	3,23
006	2,9	3,05	5,65	3,56
007	3,69	3,84	6,43	4,34
008	4,47	4,63	7,22	5,13
009	5,28	5,45	8,04	5,94
010	6,07	6,24	8,83	6,73
011	7,66	7,83	10,42	8,31
012	9,25	9,59	12,17	9,91
013	10,82	11,2	13,77	11,56
014	12,42	12,83	15,4	13,16
015	14	14,49	17,06	14,73
016	15,6	16,17	18,75	16,33
017	17,16	17,78	20,35	17,91
018	18,77	19,41	21,98	19,51
019	20,35	21,12	23,59	21,08
020	21,95	22,75	25,22	22,68
021	23,52	24,36	26,83	24,26
022	25,12	26,01	28,48	25,86
023	26,7	27,62	30,08	27,43
024	28,3	29,25	31,72	29,03
025	29,87	30,91	33,35	30,61
026	31,47	32,55	34,99	32,21
027	33,05	34,16	36,6	33,78
028	34,65	35,84	38,28	35,38

O-ring		BAE		
 1.78		ISO 3601-2:2008		Standard
Or ref.	ID	ID	OD	ID
029	37,82	39,07	41,51	38,56
030	41	42,32	44,76	41,73
031	44,17	45,6	48,04	44,91
032	47,37	48,84	51,28	48,08
033	50,52	52,19	54,6	51,26
034	53,67	55,43	57,84	54,43
035	56,87	58,67	61,08	57,61
036	60,04	61,91	64,32	60,78
037	63,22	65,14	67,55	63,96
038	66,4	68,44	70,85	67,13
039	69,57	71,67	74,08	70,31
040	72,76	74,92	77,33	73,48
041	75,94	78,25	80,66	76,66
042	82,28	84,76	87,14	83,01
043	88,64	91,23	93,61	89,36
044	95	97,79	100,17	95,71
045	101,34	104,27	106,65	102,06
046	107,7	110,82	113,2	108,41
047	114	117,3	119,68	114,76
048	120,4	123,8	126,15	121,11
049	126,76	130,46	132,81	127,46
050	133,1	136,94	139,29	133,81

Add 1000 to the o-ring reference in order to have the corresponding ISO 3601-1:2008

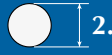
O-ring		BAE		
		ISO 3601-2:2008		Standard
Or ref	ID	ID	OD	ID
102	1,24	1,38	5,38	1,96
103	2,06	2,21	6,2	2,77
104	2,84	2,99	6,98	3,56
105	3,63	3,79	7,78	4,34
106	4,42	4,58	8,57	5,13
107	5,23	5,39	9,39	5,94
108	6,02	6,19	10,18	6,73
109	7,6	7,82	11,8	8,31
110	9,19	9,44	13,41	9,91
111	10,78	11,14	15,12	11,48
112	12,37	12,77	16,75	13,08
113	13,95	14,42	18,4	14,66
114	15,54	16,1	20,09	16,26
115	17,13	17,72	21,7	17,83
116	18,72	19,35	23,33	19,43
117	20,29	20,97	24,95	21,11
118	21,9	22,71	26,58	22,68
119	23,47	24,32	28,19	24,28
120	25,07	25,96	29,83	25,86
121	26,65	27,56	31,43	27,46
122	28,25	29,19	33,06	29,03
123	29,83	30,88	34,72	30,63
124	31,42	32,51	36,35	32,21
125	33	34,12	37,96	33,81
126	34,6	35,75	39,59	35,38
127	36,17	37,36	41,2	36,98
128	37,77	38,99	42,83	38,56
129	39,35	40,67	44,51	40,16
130	40,95	42,31	46,15	41,73
131	42,52	43,92	47,76	43,33
132	44,12	45,55	49,39	44,91
133	45,7	47,15	50,99	46,51
134	47,3	48,78	52,62	48,08
135	48,9	50,51	54,32	49,68
136	50,47	52,11	55,92	51,26
137	52,07	53,74	57,55	52,86
138	53,65	55,34	59,15	54,43
139	55,25	56,98	60,79	56,03
140	56,82	58,59	62,4	57,61
141	58,42	60,3	64,11	59,21

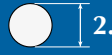
O-ring		BAE		
		ISO 3601-2:2008		Standard
Or ref	ID	ID	OD	ID
142	60	61,9	65,71	60,78
143	61,6	63,54	67,35	62,38
144	63,17	65,14	68,95	63,96
145	64,77	66,78	70,59	65,56
146	66,35	68,38	72,19	67,13
147	67,95	70,07	73,88	68,73
148	69,52	71,67	75,48	70,31
149	71,12	73,3	77,11	71,91
150	72,7	74,91	78,72	73,48
151	75,88	78,2	82,01	76,66
152	82,22	84,71	88,49	83,01
153	88,58	91,18	94,96	89,36
154	94,93	97,76	101,54	95,71
155	101,28	104,24	108,02	102,06
156	107,63	110,77	114,55	108,41
157	113,98	117,24	121,02	114,76
158	120,33	123,75	127,5	121,11
159	126,67	130,36	134,11	127,46
160	133	136,84	140,59	133,81
161	139,38	143,32	147,07	140,16
162	145,73	149,79	153,54	146,51
163	152,07	156,27	160,02	152,86
164	158,43	162,88	166,63	159,21
165	164,78	169,36	173,11	165,56
166	171,13	175,83	179,58	171,91
167	177,48	182,35	186,06	178,26
168	183,83	188,95	192,66	184,61
169	190,18	195,43	199,14	190,96
170	196,53	201,9	205,61	197,31
171	202,88	208,38	212,09	203,66
172	209,23	214,99	218,7	210,01
173	215,58	221,47	225,18	216,36
174	221,93	227,94	231,65	222,71
175	228,28	234,42	238,13	229,06
176	234,63	241,03	244,74	235,41
177	240,98	247,51	251,22	241,76
178	247,33	254,01	257,69	248,11

Add 1000 to the o-ring reference in order to have the corresponding ISO 3601-1:2008

O-ring		BAE		
 3.53		ISO 3601-2:2008		Standard
Or ref	ID	ID	OD	ID
201	4,34	4,53	9,91	5,13
202	5,94	6,17	11,53	6,73
203	7,52	7,76	13,13	8,31
204	9,12	9,38	14,74	9,91
205	10,69	11,08	16,44	11,56
206	12,29	12,71	18,07	13,16
207	13,87	14,37	19,73	14,73
208	15,47	16,06	21,41	16,33
209	17,04	17,66	23,02	17,91
210	18,64	19,32	24,67	19,46
211	20,22	20,93	26,28	21,03
212	21,82	22,64	27,91	22,63
213	23,4	24,24	29,51	24,21
214	25	25,87	31,14	25,81
215	26,57	27,49	32,76	27,38
216	28,17	29,17	34,44	28,98
217	29,75	30,8	36,04	30,56
218	31,34	32,43	37,67	32,16
219	32,93	34,04	39,28	33,88
220	34,52	35,68	40,92	35,48
221	36,1	37,28	42,52	37,06
222	37,7	38,99	44,23	38,66
223	40,87	42,24	47,48	41,83
224	44,05	45,47	50,71	45,01
225	47,23	48,79	54,03	48,18
226	50,4	52,06	57,27	51,36
227	53,57	55,3	60,51	54,53
228	56,75	58,59	63,8	57,71
229	59,92	61,83	67,04	60,88
230	63,1	65,06	70,27	64,06
231	66,27	68,31	73,52	66,83
232	69,44	71,64	76,85	70,00
233	72,62	74,88	80,09	73,18
234	75,8	78,12	83,33	76,35
235	78,97	81,39	86,57	79,53
236	82,14	84,63	89,81	82,70
237	85,32	87,87	93,05	85,88
238	88,5	91,1	96,28	89,05
239	91,67	94,45	99,63	92,23
240	94,84	97,68	102,86	95,40
241	98,02	100,92	106,1	98,58
242	101,2	104,16	109,34	101,75

O-ring		BAE		
 3.53		ISO 3601-2:2008		Standard
Or ref	ID	ID	OD	ID
243	104,37	107,4	112,58	104,93
244	107,54	110,69	115,87	108,10
245	110,72	113,93	119,11	111,28
246	113,9	117,16	122,34	114,45
247	117,07	120,44	125,59	117,63
248	120,24	123,67	128,82	121,11
249	123,42	127,05	132,2	124,28
250	126,6	130,28	135,43	127,46
251	129,77	133,52	138,67	130,63
252	132,94	136,76	141,91	133,81
253	136,12	140	145,15	136,98
254	139,3	143,23	148,38	140,16
255	142,47	146,48	151,63	143,33
256	145,65	149,71	154,86	146,51
257	148,82	152,95	158,1	149,68
258	152	156,19	161,34	152,86
259	158,35	162,8	167,95	159,21
260	164,7	169,27	174,42	165,56
261	171,05	175,75	180,9	171,91
262	177,4	182,27	187,38	178,26
263	183,75	188,87	193,98	184,61
264	190,1	195,34	200,45	190,96
265	196,45	201,82	206,93	197,31
266	202,8	208,3	213,41	203,66
267	209,15	214,91	220,02	210,01
268	215,5	221,39	226,5	216,36
269	221,85	227,86	232,97	222,71
270	228,2	234,34	239,45	229,06
271	234,55	240,95	246,06	235,41
272	240,9	247,43	252,54	241,76
273	247,25	253,93	259,01	248,11
274	253,6	260,41	265,49	254,46
275	266,3	273,36	278,44	267,16
276	279	286,57	291,65	279,86
277	291,7	299,53	304,61	292,56
278	304,4	312,48	317,56	305,26
279	329,8	338,43	343,47	330,66
280	355,2	364,34	369,38	356,06
281	380,6	390,24	395,28	381,46
282	405,26	412,65	417,65	406,12
283	430,66	441,74	446,74	431,52
284	456,06	467,78	472,78	456,92

Add 1000 to the o-ring reference in order to have the corresponding ISO 3601-1:2008

O-ring		BAE		
		ISO 3601-2:2008		Standard
Or ref	ID	ID	OD	ID
309	10,46	10,83	19	11,43
310	12,07	12,47	20,64	13,03
311	13,64	14,13	22,3	14,61
312	15,24	15,81	23,98	16,21
313	16,81	17,41	25,58	17,78
314	18,42	19,08	27,24	19,38
315	19,99	20,68	28,84	20,96
316	21,59	22,37	30,48	22,56
317	23,16	24,01	32,08	24,13
318	24,77	25,65	33,72	25,73
319	26,34	27,25	35,32	27,31
320	27,94	28,93	37	28,91
321	29,51	30,57	38,61	30,48
322	31,12	32,21	40,25	32,08
323	32,69	33,81	41,85	33,43
324	34,29	35,44	43,48	35,26
325	37,47	38,77	46,81	38,43
326	40,65	42	50,04	41,61
327	43,82	45,24	53,28	44,78
328	47	48,48	56,52	47,96
329	50,16	51,83	59,84	51,13
330	53,34	55,07	63,08	54,31
331	56,52	58,31	66,32	57,61
332	59,7	61,54	69,55	60,78
333	62,87	64,84	72,85	63,96
334	66,04	68,07	76,08	67,13
335	69,22	71,31	79,32	70,31
336	72,4	74,55	82,56	73,48
337	75,57	77,89	85,8	76,66
338	78,74	81,16	89,14	79,83
339	81,92	84,4	92,38	83,13
340	85,1	87,63	95,61	86,31
341	88,27	90,88	98,86	89,48
342	91,44	94,21	102,19	92,66
343	94,62	97,46	105,44	95,83
344	97,8	100,69	108,67	99,01
345	100,97	103,93	111,91	102,31
346	104,14	107,17	115,15	105,49
347	107,32	110,46	118,44	108,66
348	110,5	113,7	121,68	111,84

O-ring		BAE		
		ISO 3601-2:2008		Standard
Or ref	ID	ID	OD	ID
349	113,67	116,94	124,92	115,01
350	116,84	120,17	128,15	118,19
351	120,02	123,45	131,4	121,36
352	123,2	126,88	134,63	124,54
353	126,37	130,11	138,06	127,71
354	129,54	133,34	141,29	130,89
355	132,72	136,58	144,53	134,06
356	135,9	139,82	147,77	137,24
357	139,07	143,06	151,01	140,41
358	142,24	146,29	154,24	143,59
359	145,42	149,54	157,49	146,76
360	148,6	152,77	160,72	149,94
361	151,77	156,01	163,96	153,11
362	158,12	162,57	170,52	159,46
363	164,47	169,05	177	165,81
364	170,82	175,53	183,48	172,16
365	177,17	182,04	189,95	178,51
366	183,52	188,64	196,55	184,86
367	189,87	195,12	203,03	191,21
368	196,22	201,6	209,51	197,56
369	202,57	208,07	215,98	203,91
370	208,92	214,68	222,59	210,26
371	215,27	221,16	229,07	216,61
372	221,62	227,64	235,55	222,96
373	227,97	234,11	242,02	229,31
374	234,32	240,72	248,63	235,66
375	240,67	247,2	255,11	242,01
376	247,02	253,71	261,59	248,36
377	253,37	260,19	268,07	254,71
378	266,07	273,26	281,14	267,41
379	278,77	286,22	294,1	280,11
380	291,47	299,3	307,18	292,81
381	304,17	312,26	320,14	305,51
382	329,57	338,2	346,04	330,91
383	354,97	364,25	372,09	356,31
384	380,37	390,15	397,99	381,71
386	430,66	441,74	449,54	432
387	456,06	467,78	475,58	457,4
388	481,46	493,74	501,54	482,75
389	506,86	519,81	527,57	508,15

90



O-ring		BAE		
 5.33		ISO 3601-2:2008		Standard
Or ref	ID	ID	OD	ID
390	532,26	545,72	553,48	533,55
394	533,48	649,61	657,33	634,82
391	557,66	571,76	579,52	558,95

Add 1000 to the o-ring reference in order to have the corresponding ISO 3601-1:2008

O-ring		BAE		
 5.33		ISO 3601-2:2008		Standard
Or ref	ID	ID	OD	ID
392	582,68	597,5	605,26	584,02
393	608,08	623,53	631,29	609,42
395	658,88	675,65	683,37	660,22

O-ring		BAE		
 6.99		ISO 3601-2:2008		Standard
Or ref	ID	ID	OD	ID
425	113,67	117,02	127,8	115,6
426	116,84	120,28	131,03	118,77
427	120,02	123,53	134,28	121,95
428	123,2	126,76	137,51	125,12
429	126,37	130,11	140,86	128,3
430	129,54	133,34	144,09	131,47
431	132,72	136,58	147,33	134,65
432	135,9	139,82	150,57	137,82
433	139,07	143,06	153,81	141
434	142,24	146,29	157,04	144,17
435	145,42	149,54	160,29	147,35
436	148,6	152,77	163,52	150,52
437	151,77	156,01	166,76	153,7
438	158,12	162,57	173,32	159,36
439	164,47	169,05	179,8	165,71
440	170,82	175,53	186,28	172,06
441	177,17	182,04	192,75	178,41
442	183,52	188,64	199,35	184,76
443	189,87	195,12	205,83	191,11
444	196,22	201,6	212,67	197,46
445	202,57	208,07	219,15	203,81
446	215,27	221,29	232,36	216,51
447	227,97	234,25	245,31	229,21
448	240,67	247,2	258,26	241,91
449	253,57	260,19	271,21	254,61

O-ring		BAE		
 6.99		ISO 3601-2:2008		Standard
Or ref	ID	ID	OD	ID
450	266,07	273,26	284,3	267,31
451	278,77	286,22	297,25	280,01
452	291,47	299,17	310,21	292,71
453	304,17	312,32	323,16	305,41
454	316,87	325,12	336,01	318,11
455	329,57	338,07	349,07	330,81
456	342,27	351,29	362,28	343,51
457	354,97	364,25	375,23	356,21
458	367,67	377,2	388,19	368,91
459	380,37	390,15	401,14	381,61
460	393,07	403,15	414,09	394,31
461	405,26	415,71	426,66	406,5
462	417,96	428,67	439,61	419,2
463	430,66	441,74	452,7	431,9
464	443,36	454,83	465,79	444,6
465	456,06	467,78	478,74	457,3
466	468,76	480,74	491,69	470
467	481,46	493,83	504,76	482,7
468	494,16	506,82	517,72	495,4
469	506,86	519,9	530,8	508,1
470	532,26	545,8	556,71	533,5
471	557,66	571,84	582,73	558,9
472	582,68	597,5	608,39	584,3
473	608,08	623,53	634,43	609,7
474	633,48	649,61	660,47	635,1
475	658,88	675,65	686,51	660,5

Add 1000 to the o-ring reference in order to have the corresponding ISO 3601-1:2008



O-Rings 62 

JT4 X-Rings 78 

Backup Rings (BAE) 84 

## Rubber Cord

94



JR Fitting Seals 96 

Bonded Seals 100 

Triclover Clamp Seals 108 

O-Ring Seals 114 

SMS Seals 118 

Macon Seals 122

Aseptic O-Rings DIN 11864 126

# 1. RUBBER CORD

## a) Definition

A basic sealing element used on large flanges, lids, covers or casings. The cord is cut to the required length, and then glued. In this case, both ends must be bevelled, to provide a bigger bonding surface.

## b) Characteristics

### ✓ Material

Materials are the same as for O-rings (page 67):

- NBR
- FKM
- CR
- EPDM
- VMQ (silicone) red or transparent.

Hardness ranges from 60 to 90±8 IRHD  
For more information, see page 35.

### ✓ Profiles

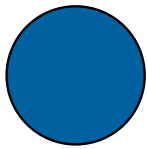

*O-ring cross-section*

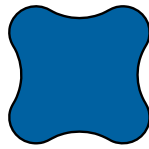

*JT4 cross-section*



*Square cross-section*



*Rectangular cross-section*

### ✓ Tolerances on the cross-section according to ISO 3302 E2

S	±
0 - 1.5	0.25
1.5 - 2.5	0.35
2.5 - 4.0	0.40
4.0 - 6.3	0.50
6.3 - 10	0.70
10 - 16	0.80
16 - 25	1.00
25 - 40	1.30
40 - 63	1.60
63 - 100	2.00





O-Rings 62 

JT4 X-Rings 78 

Backup Rings (BAE) 84 

Rubber Cord 94 

## JR fitting Seals

96



Bonded Seals 100 

Triclover Clamp Seals 108 

O-Ring Seals 114 

SMS Seals 118 

Macon Seals 122

Aseptic O-Rings DIN 11864 126

# 1. JR FITTING SEALS

## a) Definition

Techné JR fitting seals are used in male threaded connexions in hydraulic applications. Its simple shape allows a quick and easy mounting. Contrary to the O-ring it will not twist in its groove.

Its dimensions are in accordance with the DIN 3869, DIN 3852 and European ISO 9974-2 : 2000 & ISO 1179-2 :2008 regulations.

Techné JR seal withstand pressures up to 600 bars.

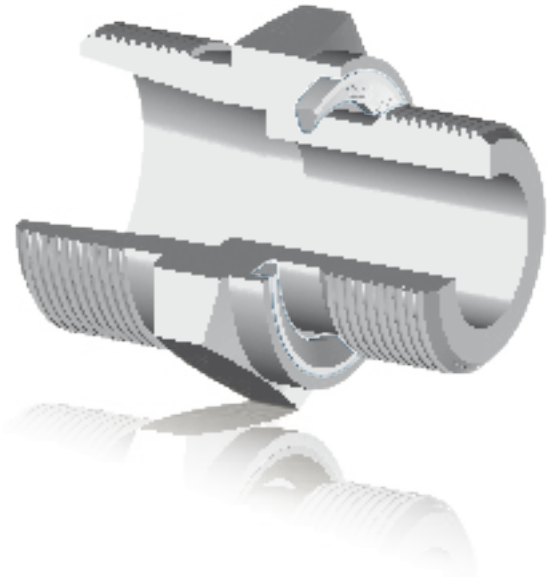

## b) Characteristics

### ✓ Materials

- Black coloured NBR 85 ±5 IRHD
- Green coloured FKM 80 ±5 IRHD
- Violet coloured EPDM 85 ±5 IRHD.

On request, Techné provides other materials (HNBR, FFKM, etc)

96

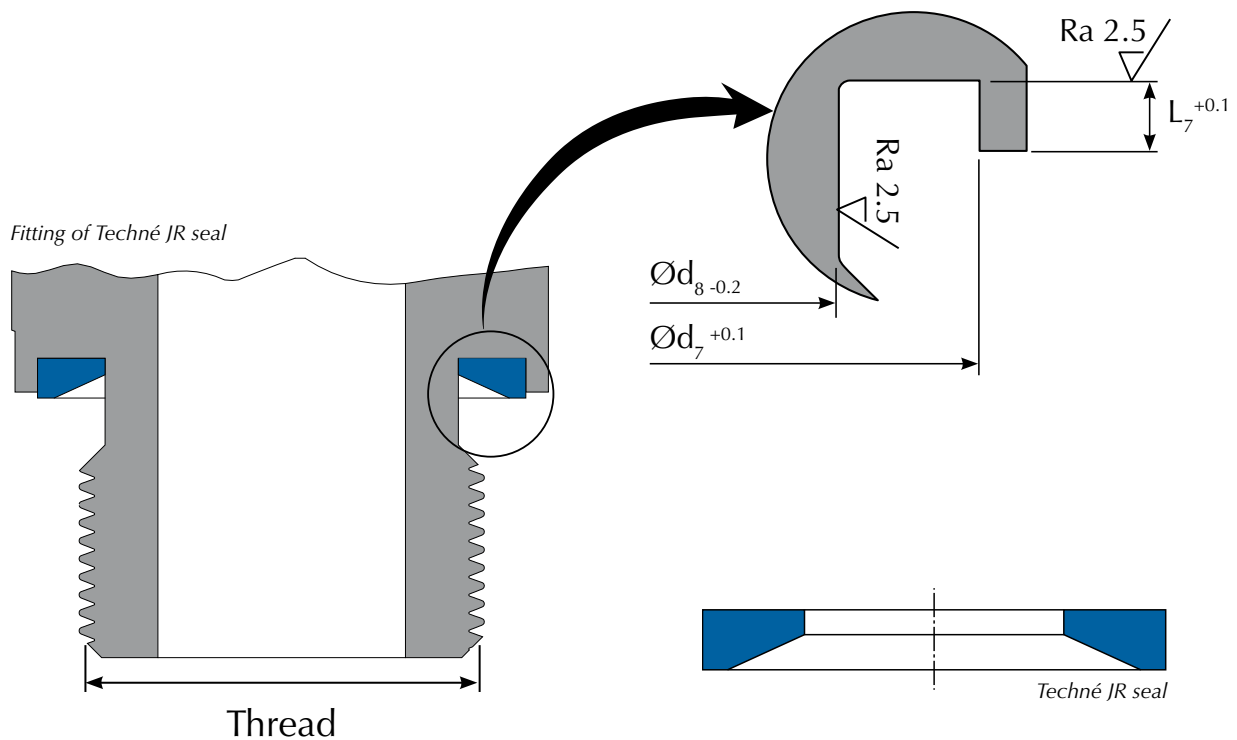

## c) Dimensions

For groove and thread dimensions, please refer to the DIN 3852. The following list contains most popular dimensions, however Techné can provide other dimensions on request.

For the mounting conditions, please refer to Techné "O-Rings" on page 76. Because JR seals are not symmetrical seals, mounting direction has to be taken into account, see previous drawing.

JR	Techné reference			Thread		Advised dimensions		
	NBR	FKM	EPDM	ISO	GAS	d <sub>8</sub>	d <sub>7</sub>	L <sub>7</sub>
8	04.0601.0008	04.0651.0008	04.0670.0008	M8 x 1		6.4	10	0.7
10	04.0601.0010	04.0651.0010	04.0670.0010	M10 x 1	1/8"	8.3	12	0.7
12	04.0601.0012	04.0651.0012	04.0670.0012	M12 x 1.5		9.7	14.5	1.2
14	04.0601.0014	04.0651.0014	04.0670.0014	M14 x 1.5	1/4"	11.7	16.6	1.2
16	04.0601.0016	04.0651.0016	04.0670.0016	M16 x 1.5		13.7	19	1.2
17	04.0601.0017	04.0651.0017	04.0670.0017		3/8"	14.7	19	1.2
18	04.0601.0018	04.0651.0018	04.0670.0018	M18 x 1.5		15.7	21	1.2
20	04.0601.0020	04.0651.0020	04.0670.0020	M20 x 1.5		17.7	23	1.2
21	04.0601.0021	04.0651.0021	04.0670.0021		1/2"	18.4	24	1.2
22	04.0601.0022	04.0651.0022	04.0670.0022	M22 x 1.5		19.7	24.5	1.2
24	04.0601.0024	04.0651.0024	04.0670.0024	M24 x 1.5		21.7	26.5	1.2
27 <sup>1</sup>	04.0601.0027	04.0651.0027	04.0670.0027	M27 x 2	3/4"	23.8	29.3	1.2
30	04.0601.0030	04.0651.0030	04.0670.0030	M30 x 2		27.6	33	1.6
33	04.0601.0033	04.0651.0033	04.0670.0033	M33 x 2	1"	29.6	36	1.6
42	04.0601.0042	04.0651.0042	04.0670.0042	M42 x 2	1"1/4	38.6	46	1.6
48	04.0601.0048	04.0651.0048	04.0670.0048	M48 x 2	1"1/2	44.5	51	1.6
60	04.0601.0060	04.0651.0060	04.0670.0060	M60 x 2	2"	56.3	67	3.2

<sup>1</sup>Similar to 26, M26 x 1.5.

To reduce mounting effort and improve the production line's rate Techné can offer suitable coatings for JR seals. See page 53.



O-Rings 62 

JT4 X-Rings 78 

Backup Rings (BAE) 84 

Rubber Cord 94 

JR Fitting Seals 96 

## Bonded Seals

100



Triclover Clamp Seals 108 

O-Ring Seals 114 

SMS Seals 118 

Macon Seals 122

Aseptic O-Rings DIN 11864 126

# 1. BONDED SEALS

## a) Definition

Techné bonded seals are steel rings with a bonded elastomer lip. The bonded seal provides sealing to connectors, or thread caps. This tough seal withstands high pressures and is replacing step by step copper seals.

## b) Characteristics

### ✓ Profiles

In order to meet the standardisation and mountings requirements, Techné offers four different profiles:

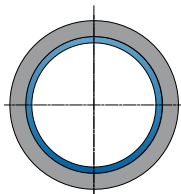
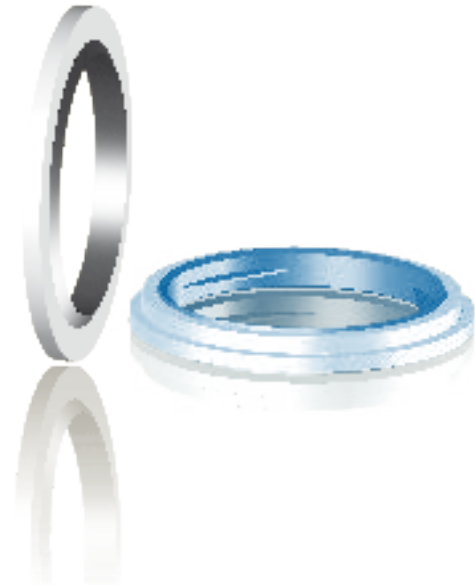

TBS

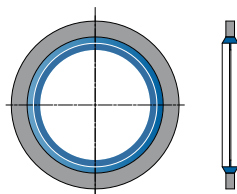
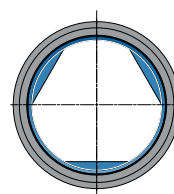
SELF CENTERING TBS  
(SCR)

KDS

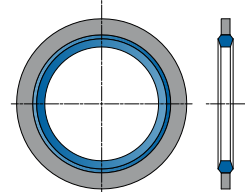

TGM 1000

### TBS

The most widespread bonded seal, it is adaptable to all types of connectors or threads: PSM, ISO, metric and imperial.

### SELF-CENTERING TBS

Similar to the TBS bonded seal, it has a thin lip of rubber that enables the centering of the seal with the thread. Because of it not falling, it is strongly recommended for vertical applications.

### KDS

Due to the shape of steel ring, the elastomer has not only a chemical grip but also a mechanical one. With its external L shape, KDS bonded seal is suitable for Banjo connectors. Due to the heat treatment of the metal ring, this seal is recommended for high pressures (up to 600 bar).

### TGM 1000

Similar to the TBS, but has a better resistance to pressure.

## ✓ Different steel material

The metal case of the bonded seal is chosen according to the pressure and the oxidation attacks it will undergo. To characterise its pressure resistance, tensile tests are performed.

Steel	Coating (ISO 4042)	Tensile strength	Salt spray resistance (ISO 9227) <sup>1</sup>
DC01-270	Zn (5µm)	> 270 Mpa	300 h
	ZnNi (12µm)		720 h
DC01-590	Zn (5µm)	> 540 Mpa	300 h
	ZnNi (12µm)		720 h
Stainless steel AISI 304	Passivation	> 540 Mpa	500h
Stainless steel AISI 316		> 540 Mpa	2000h
Stainless steel AISI 316 L		> 540 Mpa	>2000h

<sup>1</sup>Indicative values

## ✓ Different elastomer material

Depending on the pressure, environment and fluid that needs sealing, Techné offers different materials:

- NBR 80±5 IRHD
- HNBR 80±5 IRHD
- FKM 80±5 IRHD
- EPDM 80±5 IRHD.

On request, Techné can provide different hardnesses: 85 or 90 IRHD. To know more about the different characteristics of these materials (chemical resistance, temperature range, etc, see page 35).



## ✓ Mounting

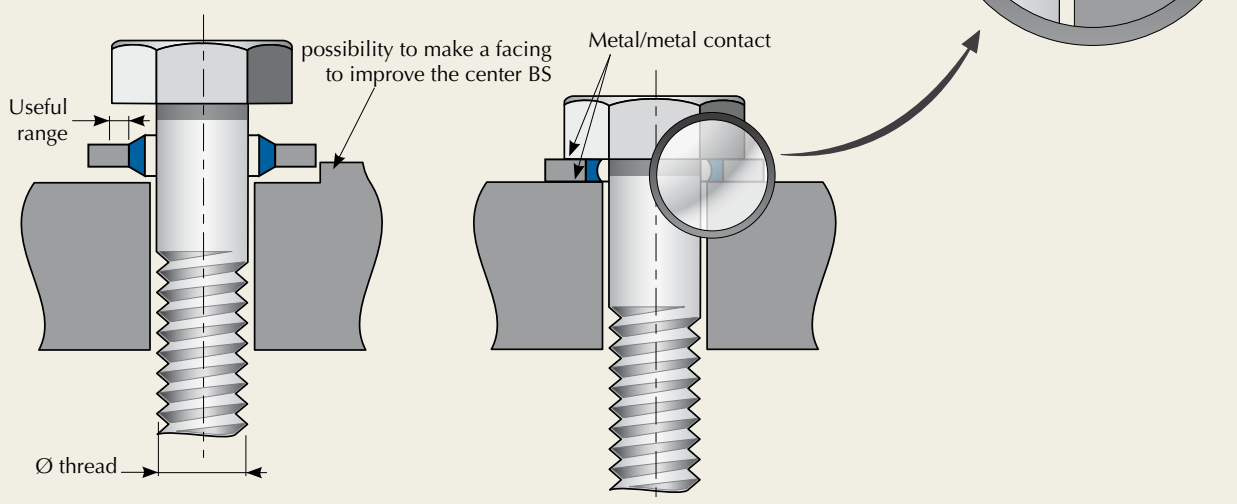

✓ Clamping force

Metric pitch	Bolt	BSP	Force (N.m)
≤ 8	5/16		5.3
10	3/8	1/8	7.1
11	7/16		11.8
12	1/2	1/4	15.8
14	9/16		22.6
16	5/8	3/8	30.5
18	3/4		40.7
20	13/16	1/2	56.5
22	7/8	5/8	67.8
24	1	3/4	73.4
≥ 27	1,1/16		79.0

✓ TBS range

NBR or FKM 80+/-5 IRHD with DC01-270 class steel ring.  
Other compositions are available on request.

**BOLT CLAMP**

TBS corresponds to standard Ø of bolt

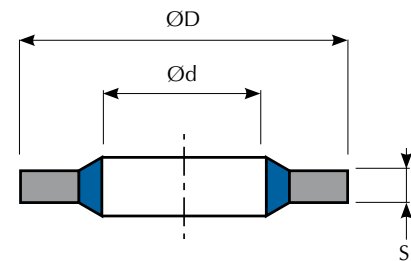
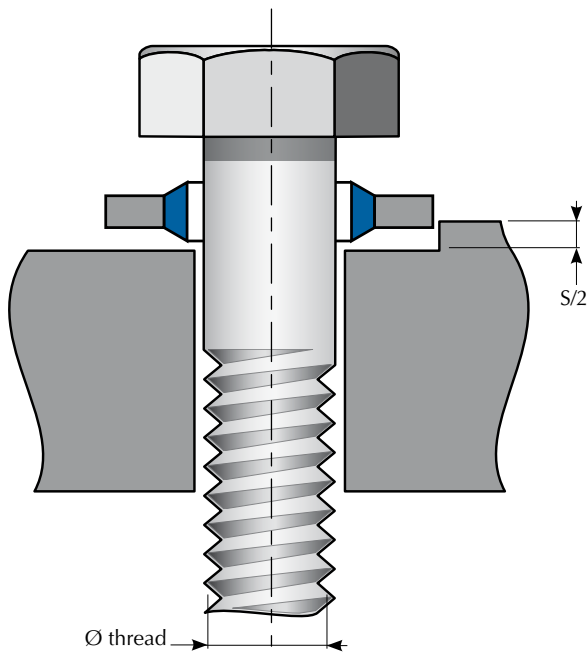

**BANJO CLAMP**

TBS corresponds to the standard Ø of the hollow screw

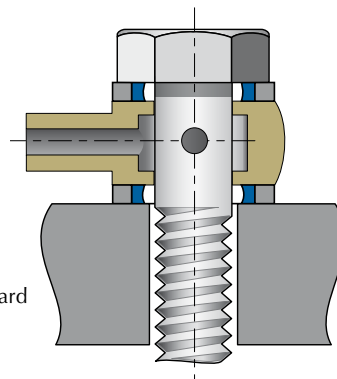



## INCH DIMENSIONS

NBR 80	FKM 80	BSP	Bolt	Type	d	D	S
03.0300.0006			6BA	001	3,05	6,35	1,20
03.0300.0007			4BA	002	4,12	7,26	1,20
03.0300.5284			2BA	003	5,21	8,38	1,20
03.0300.0072			1/4	005	6,99	13,34	1,20
03.0300.0341			5/16	006	8,31	13,34	1,20
03.0300.0065			5/16	007	8,64	14,22	1,20
03.0300.0115			40	008	11,26	18,36	2,00
03.0300.0120			7/16	009	11,69	19,05	2,00
03.0300.0150			9/16	010	14,86	22,23	2,00
03.0300.3002			11/16	011	16,51	25,40	2,00
03.0300.0180			11/16	012	18,16	25,40	2,30
03.0300.0210			15/16	013	24,26	33,27	2,30
03.0300.0243			1 1/8	014	29,33	36,58	2,30
03.0300.0252			1 1/4	015	32,64	41,40	3,20
03.0300.0270			1 3/8	016	35,94	44,45	3,20
03.0300.0275			1 1/2	017	38,96	47,75	3,20
03.0300.0280			1 3/4	018	45,34	57,15	3,20
03.0300.0295			2	019	51,69	63,50	3,20
03.0300.0100			3/8	020	10,37	15,88	2,00
03.0300.0140		1/4	1/2	021	13,74	20,57	2,00
03.0300.0155			60	022	15,83	22,23	2,00
03.0300.3000	03.0380.1725	3/8		023	17,28	23,80	2,00
03.0300.0190			3/4	024	19,69	26,92	2,30
03.0300.0200		1/2	13/16	025	21,54	28,58	2,50
03.0300.2154		1/2	13/16	(025)	21,54	28,58	2,00
03.0300.0209		5/8	7/8	026	23,49	31,75	2,30
03.0300.0225		3/4	1,00	027	27,05	34,93	2,50
03.0300.0014		1	3/4	(027)	27,05	34,93	2,30
03.0300.2784			1 1/16	028	27,82	38,61	2,30
03.0300.0245		7/8	1 3/16	029	30,81	38,10	2,30
03.0300.0260		1.0	1 5/16	030	33,89	42,80	3,20
03.0300.0255		1.0	1 5/16	031	33,89	42,80	2,30
03.0300.0292		1.1/4	1 5/8	032	42,93	52,38	3,20
03.0300.0285	03.0380.0011	1.1/2	1 7/8	033	48,44	58,60	3,20
03.0300.0298		1.3/4	2 1/8	034	54,89	69,85	3,20
03.0300.0299			2 1/4	035	58,04	70,36	3,20
03.0300.0300	03.0380.0010	2.0		036	60,58	73,03	3,20
03.0300.0310			2 1/2	037	64,39	77,72	3,20
03.0300.0315		2 + 1/4		038	66,68	79,50	3,20
03.0300.0325		2 + 1/2		039	76,08	90,17	3,4



Non exhaustive list, Techné supplies all specific inch dimensions.

## METRIC DIMENSIONS

NBR 80	FKM 80	M	Type	d	D	S
03.0300.3675		M3	301	3,60	7,50	1,00
03.0300.0033		M3,5	201	4,10	7,20	1,00
03.0300.0008		M4	202	4,50	7,00	1,00
03.0300.0654	03.0380.0004	M5	302	4,60	9,00	1,00
03.0300.5610		M5	303	5,60	10,00	1,00
03.0300.3005		M5	203	5,70	9,00	1,00
03.0300.0010		M5	204	5,70	10,00	1,00
03.0300.0340	03.0380.6292	M5(5,5)	205	6,20	9,20	1,00
03.0300.6611	03.0380.6611	M6	304	6,60	11,00	1,00
03.0300.0040		M6	206	6,70	10,00	1,00
03.0300.0045	03.0380.0006	M6	207	6,70	11,00	1,00
03.0300.6711		M6	208	6,70	11,00	2,50
03.0300.0070		M6	305	6,85	13,27	1,30
03.0300.0071		M6	306	7,00	11,40	1,00
03.0300.0050		M6 (6,5)	209	7,10	12,00	1,00
03.0300.0073		M6 (6,7)	210	7,30	10,20	1,00
03.0300.0055	03.0380.8513	M8	211	8,50	13,40	1,00
03.0300.0086	03.0380.8613	M8	307	8,60	13,00	1,00
03.0300.0080	03.0380.8713	M8	212	8,70	13,00	1,00
03.0300.0060	03.0380.0013	M8	213	8,70	14,00	1,00
03.0300.0067		M8	214	8,70	16,00	1,00
03.0300.0093		M8.5	215	9,30	13,30	1,00
03.0300.3006		M10	216	10,35	16,00	2,00
03.0300.0101		M1/8"	510	10,40	14,70	1,20
03.0300.0110	03.0380.0107	M10	217	10,70	16,00	1,50
03.0300.0107	03.0380.0007	M10	310	10,70	17,00	1,50
03.0300.0105		M12	218	10,70	18,00	1,50
03.0300.0114		M11	219	11,40	16,30	1,50
03.0300.0126		M11	312	11,80	18,10	1,50
03.0300.0125		M11	221	11,80	19,10	1,50
03.0300.0130	03.0380.1271	M12	222	12,70	18,00	1,50
03.0300.1271	03.0380.0012	M12	313	12,70	19,00	1,50
03.0300.0135		M12	223	12,70	20,00	1,50
03.0300.1370		M12	224	13,70	20,00	1,50
03.0300.0142		M13	225	13,70	22,00	1,50
03.0300.0137		M13	315	13,80	20,10	1,50
03.0300.0138		M13.5"	511	13,85	18,70	1,20
03.0300.0146		M13(13,5)	226	14,00	18,70	1,50
03.0300.1472	03.0380.0147	M14	316	14,70	21,00	1,50
03.0300.0145	03.0380.1472	M14	227	14,70	22,00	1,50
03.0300.3001		M15	228	16,00	22,70	1,50
03.0300.0165		M16	317	16,70	23,00	1,50
03.0300.1692	03.0380.1672	M17	229	16,70	24,00	1,50
03.0300.0171		M3/8"	512	17,35	22,70	1,20



NBR 80	FKM 80	M	Type	d	D	S
03.0300.0175	03.0380.1742	M17	230	17,40	24,00	1,50
03.0300.0181		M17(17,5)	231	18,00	24,70	1,50
03.0300.0185		M18	232	18,70	26,00	1,50
03.0300.0128		M18	320	18,70	27,00	2,00
03.0300.0195		M20	233	20,70	28,00	1,50
03.0300.3007		M20	321	20,70	29,00	2,00
03.0300.0203	03.0380.2152	M21	234	21,50	28,70	2,50
03.0300.0204		M1/2"	513	21,65	26,70	1,20
03.0300.2173		M22	323	21,70	30,00	2,00
03.0300.2050		M20	235	22,50	28,00	1,50
03.0300.2273		M22	236	22,70	30,00	2,00
03.0300.0207		M22	237	22,70	30,00	3,00
03.0300.0205	03.0380.0227	M22	324	22,70	31,00	2,00
03.0300.2373		M24	325	23,70	32,00	2,00
03.0300.2473		M24	238	24,70	32,00	2,00
03.0300.0215		M24	326	24,70	33,00	2,00
03.0300.0220		M26	239	26,70	35,00	2,00
03.0300.2735		M26	327	27,00	35,30	2,00
03.0300.0230		M27	240	27,20	36,00	2,00
03.0300.2783		M3/4"	514	27,30	32,50	1,20
03.0300.2773		M27	328	27,70	36,00	2,00
03.0300.2863		M27	329	28,60	36,00	2,00
03.0300.0235		M28	241	28,70	37,00	2,00
03.0300.0240		M28 (28,5)	330	29,20	37,50	2,00
03.0300.0251		M30	331	30,70	39,00	2,00
03.0300.0250		M30	242	31,00	39,00	2,00
03.0300.3374	03.0380.0337	M33	243	33,70	42,00	2,00
03.0300.0266		M33	244	34,30	43,00	2,00
03.0300.0272	03.0380.3670	M36	245	36,70	46,00	2,00
03.0300.3637		M36	333	37,00	48,00	2,50
03.0300.3940		M39	246	40,00	51,00	2,50
03.0300.0290		M42	247	42,70	53,00	3,00
03.0300.4284		M1 1/4"	516	42,80	49,50	2,00
03.0300.4243		M42	335	43,00	54,00	2,50
03.0300.4546		M45	336	46,00	57,00	2,50
03.0300.4875		M1 1/2"	517	48,70	55,50	2,00
03.0300.0294		M48	248	48,70	59,00	3,00
03.0300.4849		M48	337	49,00	60,00	2,50
03.0300.0296		M48	249	52,00	60,00	3,00
03.0300.3003		M52	250	53,30	64,50	3,00
03.0300.6056		M2"	518	60,50	68,50	2,00
03.0300.0089		M88	254	89,09	101,48	3,20



Non exhaustive list, Techné supplies all specific metric dimensions.

## ✓ Self-centering TBS range

NBR or FKM rubber 80±5 IRHD  
with steel DC01-270.  
Other compounds on request.

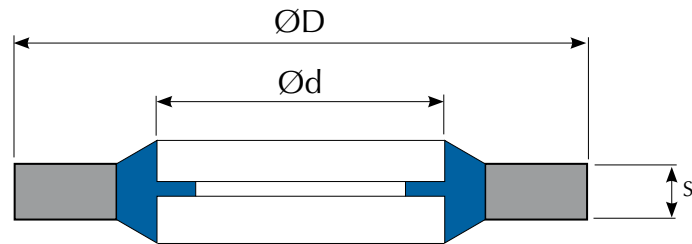

### INCH DIMENSIONS

NBR 80	BSP	Bolt	Type	d	D	S
03.0400.8311		5/16	006	8,31	13,34	1,20
03.0400.1037	1/8	3/8	820	10,37	15,88	2,00
03.0400.1374	1/4	1/2	821	13,74	20,57	2,00
03.0400.1651		5/8	869	16,51	25,40	2,00
03.0400.3000		3/8	823	17,28	23,80	2,00
03.0400.1816		11/16	871	18,16	25,40	2,50
03.0400.2154	1/2	13/16	825	21,54	28,58	2,50

### METRIC DIMENSIONS

NBR 80	M	Type	d	D	S
03.0400.4691	M4	202	4,50	7,00	1,00
03.0400.0056	M5	303	5,60	10,00	1,00
03.0400.6710	M6	206	6,70	10,00	1,00
03.0400.0015	M6	207	6,70	11,00	1,00
03.0400.8713	M8	212	8,70	13,00	1,00
03.0400.0087	M8	866	8,70	14,00	1,00
03.0400.1070	M10	708	10,70	16,00	1,50
03.0400.0107	M10	310	10,70	17,00	1,50
03.0400.0127	M12	867	12,70	19,00	1,50
03.0400.1418	M13,5	226	14,00	18,70	1,50
03.0400.0014	M14	316	14,70	21,00	1,50
03.0400.0147	M14	227	14,70	22,00	1,50
03.0400.0016	M16	317	16,70	23,00	2,00
03.0400.0167	M16	870	16,70	24,00	1,50
03.0400.0187	M18	872	18,70	26,00	1,50
03.0400.0207	M20	873	20,70	28,00	1,50
03.0400.0018	M22	874	22,70	30,00	2,00

Non exhaustive list, Techné supplies all specific dimensions of self-centering TBS.



O-Rings 62 

JT4 X-Rings 78 

Backup Rings (BAE) 84 

Rubber Cord 94 

JR Fitting Seals 96 

Bonded Seals 100 

## Triclover Clamp Seals

108



O-Ring Seals 114 

SMS Seals 118 

Macon Seals 122

Aseptic O-Rings DIN 11864 126

# 1. TRICLOVER CLAMP SEALS

## a) Definition

Triclover Clamp seals are aseptic seals widely used in the food processing or pharmaceutical industries. They are exclusively mounted in Clamp tube made of two ferrules/pipe coupling and a clamp.

Depending on the country and use, new standards have seen the day. Thus there are four main standards for clamp connectors:



## b) Characteristics

### ✓ Profiles

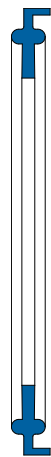

Type A

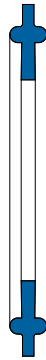

Type B<sup>1</sup>



µclamp<sup>2</sup>

<sup>1</sup>if  $d_3 = 25$ , the type B is named «clamp micro»  
 Si  $d_3 = 34$ , the type B is named «clamp mini»  
 Si  $d_3 > 34$ , the type B is named «clamp or triclamp»  
<sup>2</sup> $d_3 = 25$  (see sketch of metal ring above)

### ✓ Techné compounds & certifications :

	EPDM (Compound 334137)	FKM (Compound 33466)	VMQ (Compound 334144)	PTFE (Compound 95101)
	Black	Black	Translucent <sup>1</sup> (Peroxyd cured)	White <sup>1</sup>
Approvals	FDA	FDA	FDA	FDA
	USP VI	USP VI	USP VI	USP VI
	1935/2004	1935/2004	1935/2004	1935/2004
	3A	3A	3A	3A
		BNIC		



✓ **Techné specific compounds :**

USOD Clamp	<b>MVQ Platinum</b> 334536	<b>MVQ Platinum</b> 334603
	<i>White</i>	<i>Translucent</i>
Approvals	FDA	FDA
	USP VI	USP VI
		1935/2004

Other compounds and colours on demand. Some examples:

*FKM green: FDA, 1935/2004, USP VI*  
*MVQ PX red: FDA*  
*NBR blue: FDA, 1935/2004*

In order to avoid any mistake, Techné advises to provide following data with inquiries and orders:

- Seal's profile: A or B**
- Ferrule diameter d3 (and eventually housing diameter d5)**
- Pipe diameter and pipe thickness**
- Seal's material and list of required approvals**

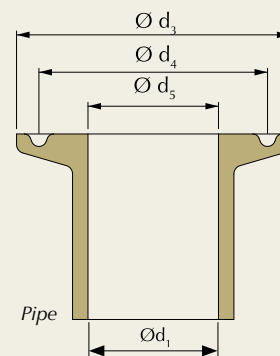

✓ **PTFE enveloped clamp seals:**

These seals consist of an outside PTFE envelop surrounding a rubber inlay. They are mostly used for chemical and pharmaceutical applications. The PTFE envelop provides a very good chemical resistance while the rubber inlay grants elasticity and sealing over time.



**Type A**





**Type B**



**µclamp**

Clamp	<b>PTFE</b> compound 95101 white		
Rubber inlay	MVQ Compound 409058 translucent	EPDM Compound 409023 black	FKM Compound 409043 white

## ✓ Caps :

	Techné Nr	Compound	
Ferrule cap Ø 25	15 9904 1210	PTFE WHITE 95101 USP-FDA-3A 1935/2004	
Ferrule cap Ø 34	15 9704 0024		
Ferrule cap Ø 50,5	15 9704 0004		
Ferrule cap Ø 64	15 9704 0019		
Ferrule cap Ø 77,5	15 9704 0022		
Ferrule cap Ø 91	15 9704 0023		
Ferrule cap Ø 106	15 9704 0005		
Ferrule cap Ø 119	15 9704 0025		

## c) Dimensions

Standard	Dimension	Ø Ferrule	Ø ID	Ø Pipe x Th.
SMS 3008	25	50,5	22,6	25 x 1,2
SMS 3008	38	50,5	35,6	38 x 1,2
SMS 3008	51	64	48,6	51 x 1,2
SMS 3008	63	77,5	60,3	63,5 x 1,6
SMS 3008	76	91	72,9	76,1 x 1,6
SMS 3008	101,6	119	97,6	101,6 x 2
SMS 3008	104	119	100	104 x 2
USOD / BS4825	1/4" µ clamp	25	4,57	6,35 x 0,89
USOD / BS4825	3/8" µ clamp	25	7,75	9,53 x 0,89
USOD / BS4825	1/2" µ clamp	25	9,40	12,7 x 1,65
USOD / BS4825	3/4" µ clamp	25	15,75	19,05 x 1,65
USOD / BS4825	3/8" mini	34	7,75	9,53 x 0,89
USOD / BS4825	1/2" mini	34	9,40	12,7 x 1,65
USOD / BS4825	3/4" mini	34	15,75	19,05 x 1,65
USOD / BS4825	1"	50,50	22,1	25,4 x 1,65
USOD / BS4825	1 1/2"	50,50	34,8	38,1 x 1,65
USOD / BS4825	2"	64	47,5	50,8 x 1,65

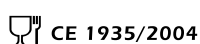

Indicative values. Techné reserves the right to change, without prior notice.





Standard	Dimension	Ø Ferrule	Ø ID	Ø Pipe x Th.
USOD / BS4825	2 1/2"	77,50	60,2	63,5 x 1,65
USOD / BS4825	3"	91	72,9	76,2 x 1,65
USOD / BS4825	3 1/2"	106	84,7	88,9 X 2,11
USOD / BS4825	4"	119	97,4	101,6 x 2,11
USOD / BS4825	4 1/2"	130	110,3	114,3 x 2
USOD / BS4825	5 1/2"	155		141,3 x 2,77
USOD / BS4825	6"	167		152,4 x 2,77
USOD / BS4825	6 5/8"	183		168,3 x 2,6
USOD / BS4825	8"	217,50		203,2 x 2,77
USOD / BS4825	8 5/8"	233,50		219,1 x 2,6
USOD / BS4825	10"	268		254 x 2,77
USOD / BS4825	12"	319		304,8 x 2,77
USOD / BS4825	12 3/4"	338		323,9 x 3,96
DIN 32676	DN 10 mini	34	10	13 x 1,5
DIN 32676	DN 15 mini	34	16	19 x 1,5
DIN 32676	DN 20 mini	34	20	23 x 1,5
DIN 32676	DN 25	50,5	26	29 x 1,5
DIN 32676	DN 32	50,5	32	35 x 1,5
DIN 32676	DN 40	50,5	38	41 x 1,5
DIN 32676	DN 50	64	50	53 x 1,5
DIN 32676	DN 65	91	66	70 x 2
DIN 32676	DN 80	106	81	85 x 2
DIN 32676	DN 100	119	100	104 x 2
DIN 32676	DN 115	130	110,3	114,3 x 2
DIN 32676	DN 125	155	125	129 X 2
DIN 32676	DN 150	183	150	154 X 2
DIN 32676	DN 200	233,5	200	204 X 2
DIN 32676	DN 250	268	250	254 X 2
DIN 32676	DN 300	319	300	304 x 2
ISO 1127	DN 6 µ clamp	25	6	8 x 1
ISO 1127	DN 8 µ clamp	25	8	10 x 1



Indicative values. Techné reserves the right to change, without prior notice.

Standard	Dimension	Ø Ferrule	Ø ID	Ø Pipe x Th.
ISO 1127	DN 10 µ clamp	25	10	12 x 1
ISO 1127	DN 12 µ clamp	25	12	14 x 1 16 x 2
ISO 1127	DN 8 µ clamp	25	10,3	13,5 x 1,6
ISO 1127	DN 10 µ clamp	25	14	17,2 x 1,6
ISO 1127	DN 18 µ clamp	25	16	18 x 1 20 x 2
ISO 1127	DN 8 mini	34	10,3	13,5 x 1,6
ISO 1127	DN 10 mini	34	14	17,2 x 1,6
ISO 1127	DN 15 mini	34	18,1	21,3 x 1,6
ISO 1127	DN 8	50,5	10,3	13,5 x 1,6
ISO 1127	DN 10	50,5	14,0	17,2 x 1,6
ISO 1127	DN 15	50,5	18,1	21,3 x 1,6
ISO 1127	DN 20	50,5	23,7	26,9 x 1,6
ISO 1127	DN 25	50,5	31,3	33,7 x 1,2
ISO 1127			30,5	33,7 x 1,6
ISO 1127			29,7	33,7 x 2
ISO 1127	DN 32	50,5	39,2	42,4 x 1,6
ISO 1127			38,4	42,4 X 2
ISO 1127	DN 32	64	38,4	42,4 x 2
ISO 1127	DN 40	64	45,1	48,3 x 1,6
ISO 1127			44,3	48,3 x 2
ISO 1127	DN 50	77,5	56,3	60,3 x 2
ISO 1127	DN 65	91	72,1	76,1 x 2
ISO 1127	DN 80	106	84,9	88,9 x 2
ISO 1127	DN 100	130	110,3	114,3 x 2
ISO 1127	DN 125	155	135,7	139,7 x 2
ISO 1127			134,5	139,7 x 2,6
ISO 1127			133,7	139,7 x 3
ISO 1127	DN 150	183	164,3	168,3 x 2
ISO 1127			163,1	168,3 X 2,6
ISO 1127			162,3	168,3 x 3
ISO 1127	DN 200	233,5	213,9	219,1 x 2,6
ISO 1127			211,1	219,1 x 4
ISO 1127	DN 250	286,1	267,8	273 x 2,6
ISO 1127	DN 300	338	318,7	323,9 x 2,6

112

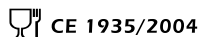

Indicative values. Techné reserves the right to change, without prior notice.

**Techné**

O-Rings 62 

JT4 X-Rings 78 

Backup Rings (BAE) 84 

Rubber Cord 94 

JR Fitting Seals 96 

Bonded Seals 100 

Triclover Clamp Seals 108 

## **D-Ring milk coupling Seals** 114

SMS Seals 118 

Macon Seals 122

Aseptic O-Rings DIN 11864 126

# 1. D-RING MILK COUPLING SEALS

## a) Definition

Techné DIN 11851 milk coupling seals are aseptic seals. Widely used in the food industry and especially in dairy lines, it is mounted in the housing according to the DIN 11850 regulation. However, the pipe-couplings can be adapted to tubes of different standards (SMS, DIN, US or BSOD, etc.). Moreover, Techné can provide specific seals on request.



## b) Characteristics

### ✓ Profiles

There are two types of profiles. The simple D-ring and the flanged D-ring. TECHNE est capable de réaliser après étude, des D-ring dimensionnellement hors standard et dans d'autres matières.



D-ring DIN 11851	Ø ID	Ø OD	H	NBR BLUE 344075B FDA 1935/2004	EPDM BLACK 334137 USP-FDA-3A 1935/2004	FKM BLACK 33466 USP-FDA- BNIC 3A 1935/2004	MVQ TRANS. 334144 USP-FDA-3A 1935/2004	PTFE WHITE 95101/23413 USP-FDA-3A 1935/2004
DN								
10	12	20	4,5	19 2123 0010	19 2520 0010	19 2320 0010	19 2225 0010	19 2922 0010
15	18	26	4,5	19 2123 0015	19 2520 0015	19 2320 0015	19 2225 0015	19 2922 0015
15H	18	26	8	19 2123 0158	19 2520 0158	19 2320 0158	19 2225 0158	19 2922 0158
20	23	33	4,5	19 2123 0020	19 2520 0020	19 2320 0020	19 2225 0020	19 2922 0020
20H	23	33	8	19 2123 0208	19 2520 0208	19 2320 0208	19 2225 0208	19 2922 0208
25	30	40	5	19 2123 0025	19 2520 0025	19 2320 0025	19 2225 0025	19 2922 0025
25H	30	40	8	19 2123 0258	19 2520 0258	19 2320 0258	19 2225 0258	19 2922 0258
32	36	46	5	19 2123 0032	19 2520 0032	19 2320 0032	19 2225 0032	19 2922 0032
32H	36	46	8	19 2123 0328	19 2520 0328	19 2320 0328	19 2225 0328	19 2922 0328
40	42	52	5	19 2123 0040	19 2520 0040	19 2320 0040	19 2225 0040	19 2922 0040
40H	42	52	8	19 2123 0408	19 2520 0408	19 2320 0408	19 2225 0408	19 2922 0408
50	54	64	5	19 2123 0050	19 2520 0050	19 2320 0050	19 2225 0050	19 2922 0050
50H	54	64	8	19 2123 0508	19 2520 0508	19 2320 0508	19 2225 0508	19 2922 0508

In Red: on demand only

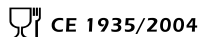

Indicative values. Techné reserves the right to change, without prior notice.



D-ring DIN 11851	Ø ID	Ø OD	H	NBR BLACK 344075B FDA 1935/2004	EPDM BLACK 334137 USP-FDA-3A 1935/2004	FKM BLACK 33466 USP-FDA BNIC 3A 1935/2004	MVQ TRANS. 334144 USP-FDA-3A 1935/2004	PTFE WHITE 95101/23413 USP-FDA-3A 1935/2004
DN								
65	71	81	5	19 2123 0065	19 2520 0065	19 2320 0065	19 2225 0065	19 2922 0065
65M	71	81	6,5	19 2123 6565	19 2520 6565	19 2320 6565	19 2225 6565	19 2922 6565
65H	71	81	8	19 2123 0658	19 2520 0658	19 2320 0658	19 2225 0658	19 2922 0658
75	78	88	5	19 2123 0075	19 2520 0075	19 2320 0075	19 2225 0075	19 2922 0075
80	85	95	5	19 2123 0080	19 2520 0080	19 2320 0080	19 2225 0080	19 2922 0080
80H	85	95	8	19 2123 0808	19 2520 0808	19 2320 0808	19 2225 0808	19 2922 0808
90	94	104	5	19 2123 0090	19 2520 0090	19 2320 0090	19 2225 0090	19 2922 0090
100	104	114	6	19 2123 0100	19 2520 0100	19 2320 0100	19 2225 0100	19 2922 0100
100H	104	114	8	19 2123 1008	19 2520 1008	19 2320 1008	19 2225 1008	19 2922 1008
125	130	142	7	19 2123 0125	19 2520 0125	19 2320 0125	19 2225 0125	19 2922 0125
125H	130	142	8	19 2123 1258	19 2520 1258	19 2320 1258	19 2225 1258	19 2922 1258
150	155	167	7	19 2123 0150	19 2520 0150	19 2320 0150	19 2225 0150	19 2922 0150
150H	155	167	8	19 2123 1508	19 2520 1508	19 2320 1508	19 2225 1508	19 2922 1508
200	204	216	7	19 2123 0200	19 2520 0200	19 2320 0200	19 2225 0200	19 2922 0200

In Red: on demand only

D-ring SMS	Ø ID	Ø OD	H	EPDM BLACK 334137 USP-FDA-3A 1935/2004	FKM BLACK 33466 USP-FDA-BNIC 3A 1935/2004	MVQ TRANS. 334144 USP-FDA-3A 1935/2004	PTFE WHITE 95101/23413 USP-FDA-3A 1935/2004
DN							
25	25	32	5,5	19 2510 0025	19 2310 0025	19 2215 0025	19 2912 0025
32	32	40	5,5	19 2510 0032	19 2310 0032	19 2215 0032	19 2912 0032
38	38	48	5,5	19 2510 0038	19 2310 0038	19 2215 0038	19 2912 0038
40	40	50	5,5	19 2510 0040	19 2310 0040	19 2215 0040	19 2912 0040
51	51	61	5,5	19 2510 0051	19 2310 0051	19 2215 0051	19 2912 0051
63	63	73,5	5,5	19 2510 0063	19 2310 0063	19 2215 0063	19 2912 0063
76	76	86	5,5	19 2510 0076	19 2310 0076	19 2215 0076	19 2912 0076
104	104	116	5,5	19 2510 0104	19 2310 0104	19 2215 0104	19 2912 0104

D-ring USOD	Ø ID	Ø OD	H	EPDM BLACK 334137 USP-FDA-3A 1935/2004	FKM BLACK 33466 USP-FDA-BNIC 3A 1935/2004	MVQ TRANS. 334144 USP-FDA-3A 1935/2004	PTFE WHITE 95101 USP-FDA-3A 1935/2004
DN							
1"	25	32	5,5	19 2540 0001	19 2340 0001	19 2245 0001	19 2942 0001
1 1/2"	38	48	5,5	19 2540 0015	19 2340 0015	19 2245 0015	19 2942 0015
2"	51	61	5,5	19 2540 0002	19 2340 0002	19 2245 0002	19 2942 0002
2 1/2"	63	73,5	5,5	19 2540 0025	19 2340 0025	19 2245 0025	19 2942 0025
3"	76	86	5,5	19 2540 0003	19 2340 0003	19 2245 0003	19 2942 0003
4"	104	116	5,5	19 2540 0004	19 2340 0004	19 2245 0004	19 2942 0004

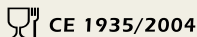

Indicative values. Techné reserves the right to change, without prior notice.

D-ring NORSK	Ø ID	Ø OD	H	NBR BLUE 344075B FDA 1935/2004	EPDM BLACK 334137 USP-FDA-3A 1935/2004
DN					
25	25	31,8	4,5	19 2153 0025	19 2550 0025
38	38	46,8	4,5	19 2153 0038	19 2550 0038
51	51	58,7	4,5	19 2153 0051	19 2550 0051
63,5	63,5	74,2	4,5	19 2153 0063	19 2550 0063
76,1	76,1	87,6	4,5	19 2153 0076	19 2550 0076
101,6	101,6	112,1	4,5	19 2153 1016	19 2550 1016

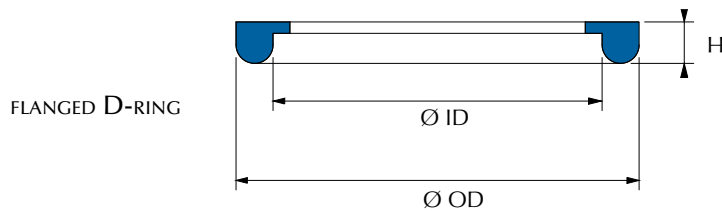

D-ring FLANGED DIN 11851	Ø ID	Ø OD	H	NBR BLUE 344075B FDA 1935/2004	EPDM BLACK 334137 USP-FDA-3A 1935/2004	FKM BLACK 33466 USP-FDA- BNIC 1935/2004	MVQ TRANS. 334144 USP-FDA-3A 1935/2004	PTFE WHITE 95101 USP-FDA-3A 1935/2004
DN								
10	12	20	5	19 6123 0010	19 6520 0010	19 6320 0010	19 6225 0010	19 6922 0010
15	18	26	5	19 6123 0015	19 6520 0015	19 6320 0015	19 6225 0015	19 6922 0015
20	23	33	5	19 6123 0020	19 6520 0020	19 6320 0020	19 6225 0020	19 6922 0020
25	30	40	5	19 6123 0025	19 6520 0025	19 6320 0025	19 6225 0025	19 6922 0025
25H	30	40	6	19 6123 0250	19 6520 0250	19 6320 0250	19 6225 0250	19 6922 0250
32	36	46	6	19 6123 0032	19 6520 0032	19 6320 0032	19 6225 0032	19 6922 0032
40	42	52	6	19 6123 0040	19 6520 0040	19 6320 0040	19 6225 0040	19 6922 0040
50	54	64	6	19 6123 0050	19 6520 0050	19 6320 0050	19 6225 0050	19 6922 0050
65	71	81	6	19 6123 0065	19 6520 0065	19 6320 0065	19 6225 0065	19 6922 0065
80	85	95	6	19 6123 0080	19 6520 0080	19 6320 0080	19 6225 0080	19 6922 0080
100	104	114	6	19 6123 0100	19 6520 0100	19 6320 0100	19 6225 0100	19 6922 0100
125	130	142	7	19 6123 0125	19 6520 0125	19 6320 0125	19 6225 0125	19 6922 0125
150	155	167	7	19 6123 0150	19 6520 0150	19 6320 0150	19 6225 0150	19 6922 0150

O-Rings 62 

JT4 X-Rings 78 

Backup Rings (BAE) 84 

Rubber Cord 94 

JR Fitting Seals 96 

Bonded Seals 100 

Triclover Clamp Seals 108 

O-Ring Seals 114 

## SMS Seals

118



Macon Seals 122

Aseptic O-Rings DIN 11864 126

# 1. SMS SEALS

## a) Definition

Techné SMS seal is an aseptic seal used in food and pharmaceutical applications. They are produced acc. SMS 1149 standard are suitable for fittings acc. SMS 1146 / 1147 standards (for tube acc. 1145 standard).



## b) Characteristics

### ✓ Profiles

2 shapes of SMS seals are available: with (profile L) and without (profile R) flange. Techné also produces on demand special SMS seals with other dimensions and compounds.

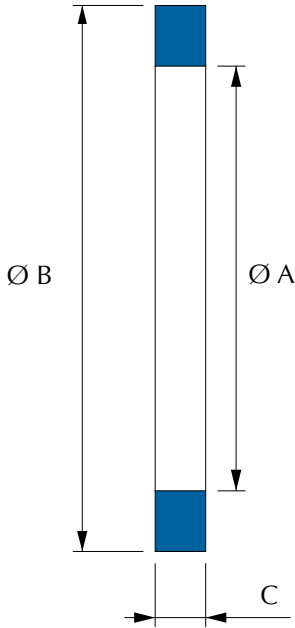

SMS R

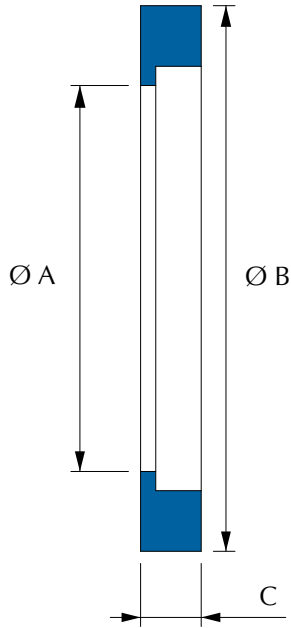

SMS L



SMS-R SMS 1149		Ø A	Ø B	C	EPDM BLACK 334137 USP-FDA-3A 1935/2004	FKM BLACK 33466 USP-FDA-BNIC 3A 1935/2004	PTFE WHITE 95101 USP-FDA-3A 1935/2004
DN							
25	25	32	5,5	19 4530 0025	19 4330 0025	19 4932 0025	
32	32	40	5,5	19 4530 0032	19 4330 0032	19 4932 0032	
38	38	48	5,5	19 4530 0038	19 4330 0038	19 4932 0038	
40*	40	50	5,5	19 4530 0040	19 4330 0040	19 4932 0040	
51	51	61	5,5	19 4530 0051	19 4330 0051	19 4932 0051	
53*	53	63	5,5				
63,5 (65*)	63,5	73,5	5,5	19 4530 0063	19 4330 0063	19 4932 0635	
76 (80*)	76	86	5,5	19 4530 0076	19 4330 0076	19 4932 0076	
89	89	101	5,5	19 4530 0089	19 4330 0089	19 4932 0089	
100*	101,6	113,5	5,5	19 4530 0100	19 4330 0100	19 4932 0100	
104*	104	116	5,5	19 4530 0104	19 4330 0104	19 4932 0104	
108	108	120	5,5	19 4530 0108	19 4330 0108	19 4932 0108	

In Red: on demand only

SMS-L SMS 1149		Ø A	Ø B	C	NBR BLACK 334270A FDA	EPDM BLACK 334137 USP-FDA-3A 1935/2004	FKM BLACK 33466 USP-FDA- BNIC 3A 1935/2004	MVQ WHITE 33421 FDA	PTFE WHITE 95101 USP-FDA-3A 1935/2004
DN									
25	22,6	31,6	5,4	19 3130 0025	19 3530 9025	19 3330 0025	19 3232 0025	19 3932 0025	
32	29,8	38,8	5,4	19 3130 0032	19 3530 0032	19 3330 0032	19 3232 0032	19 3932 0032	
38	35,5	47,5	5,6	19 3130 0038	19 3530 9038	19 3330 0038	19 3232 0038	19 3932 0038	
51	48,6	60,6	5,6	19 3130 0051	19 3530 9051	19 3330 0051	19 3232 0051	19 3932 0051	
63	60,6	73,0	5,6	19 3130 0063	19 3530 9063	19 3330 0063	19 3232 0063	19 3932 0063	
76	73,1	85,5	5,6	19 3130 0076	19 3530 9076	19 3330 0076	19 3232 0076	19 3932 0076	
101	97,4	115	5,6	19 3130 0101	19 3530 9101	19 3330 0101	19 3232 0101	19 3932 0101	
104	99,8	115	5,6	19 3130 0100	19 3530 9104	19 3330 0104	19 3232 0104	19 3932 0104	

In Red: on demand only



O-Rings 62 

JT4 X-Rings 78 

Backup Rings (BAE) 84 

Rubber Cord 94 

JR Fitting Seals 96 

Bonded Seals 100 

Triclover Clamp Seals 108 

O-Ring Seals 114 

SMS Seals 118 

## Macon Seals

122

Aseptic O-Rings DIN 11864 126

# 1. MACON SEALS

## a) Definition

Macon seals are mostly used in wine fittings and in the wine industry. Even if approvals are not required, Techné offers compounds with FDA and BNIC approvals (for FKM). Macon seals are made acc. SMS, DIN, ISO and USOD standards depending on the application.

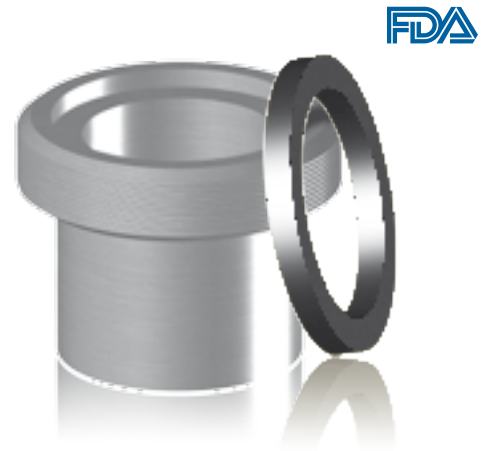

## b) Characteristics

### ✓ Profiles

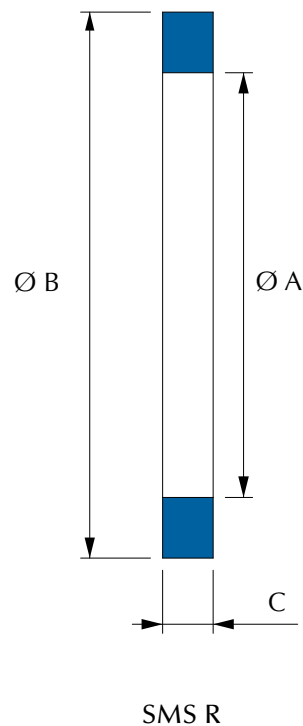



MACON Seal	ØA	ØB	C	FKM BLACK 33466 USP-FDA- BNIC 1935/2004	MVQ WHITE 33421 FDA	PTFE WHITE 95101 USP-FDA-3A 1935/2004
40	41	49	3	19 4350 0040	On demand	On demand
50	51	59	3	19 4350 0050	On demand	On demand
60	62	72	3	19 4350 0060	On demand	On demand
70	72	84	3	19 4350 0070	On demand	On demand
80	82	98	3	19 4350 0080	On demand	On demand
100	102	118	3	19 4350 0100	On demand	On demand



MACON cap Seal	ØA	C	NBR WHITE
40	55	3	07 4064 0005
50	67	3	07 4064 0006
70	90	3	07 4064 0007

Techné also offers on demand demand squared flange seals in NBR FDA white (drawing to be provided).

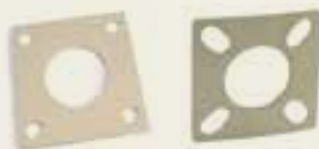

Other dimensions and compounds on demand only.

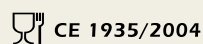



O-Rings	62
JT4 X-Rings	78
Backup Rings (BAE)	84
Rubber Cord	94
JR Fitting Seals	96
Bonded Seals	100
Triclover Clamp Seals	108
O-Ring Seals	114
SMS Seals	118
Macon Seals	122

# 1. O-RING ASEPTIC DIN 11864-1 - v.11.2008

Class A		Ø Pipe	Class B		Ø Pipe	Class C		Ø Pipe	ID - Ø	CS - Tore
DIN	CODE	DIN 11850	ISO 19 0b80	CODE	ISO 1127	USOD 19 0b4d	CODE	ISO 2037	ISO 3601-1 v.03.2012	ISO 3601-1 v.03.2012
DN 10	0010	13 x 1,5	DN 08	0008	13,5 x 1,6	1/2"	1200	12,7 x 1,65	12	3,5
			DN 10	0010	17,2 x 1,6				16	3,5
DN 15	0015	19 x 1,5				3/4"	3400	19,05 x 1,65	18	3,5
			DN 15	0015	21,3 x 1,6				20	3,5
DN 20	0020	23 x 1,5							22	3,5
						1"	0001	25,4 x 1,65	24	3,5
			DN 20	0020	26,9 x 1,6				26	3,5
DN 25	0025	29 x 1,5							28	3,5
			DN 25	0025	33,7 x 2,0				32	5
DN 32	0032	35 x 1,5							34	5
						1 1/2"	0015	38,1 x 1,65	37	5
DN 40	0040	41 x 1,5							40	5
			DN 32	0032	42,4 x 2,0				40,5	5
			DN 40	0040	48,3 x 2,0				46,5	5
						2"	0002	50,8 x 1,65	50	5
DN 50	0050	53 x 1,5							52	5
			DN 50	0050	60,3 x 2,0				58,5	5
						2 1/2"	0025	63,5 x 1,65	62	5
DN 65	0065	70 x 2,0							68	5
			DN 65	0065	76,1 x 2,0				73,5	5
						3"	0003	76,2 x 1,65	75	5
DN 80	0080	85 x 2,0							83	5
			DN 80	0080	88,9 x 2,3				86,5	5
						4"	0004	101,6 x 2,11	100	5
DN 100	0100	104 x 2,0							102	5
			DN 100	0100	114,3 x 2,3				111	5
DN 125 *	0125	129 x 2,0							127	5
DN 150 *	0150	154 x 2,0							152	5



Rubber	Standard	Colour	Approval	Techné code
EPDM	DIN	BLACK	FDA/USP VI	19 0520 CODE
PTFE	DIN	WHITE	FDA/USP VI	19 0922 CODE
FEP/FKM	DIN	BLACK/TRANS	FDA/USP VI	19 0620 CODE
EPDM	ISO	BLACK	FDA/USP VI	19 0580 CODE
PTFE	ISO	WHITE	FDA/USP VI	19 0982 CODE
FEP/FKM	ISO	BLACK/TRANS	FDA/USP VI	19 0680 CODE
EPDM	USOD	BLACK	FDA/USP VI	19 0540 CODE
PTFE	USOD	WHITE	FDA/USP VI	19 0942 CODE
FEP/FKM	USOD	BLACK/TRANS	FDA/USP VI	19 0640 CODE





# Appendice

# CHEMICAL RESISTANCE TABLE

	NBR	HNBR	EPDM	FKM	FKM	ACM	CR	VMQ	FVMQ	AU	PTFE	IIR
<b>A</b>												
Acetaldehyde	o	o	**	o	***	o	-	**	o	o	***	**
Acetamide	***	**	***	o	**	**	***	o	***	***	***	***
Acetic Acid 30%	**	-	***	**	***	o	***	***	**	-	-	**
Acetic acid, 96-99.5% (Glacial)	*	-	***	*	***	o	o	**	o	o	***	**
Acetic Anhydride	*	o	**	o	***	o	**	*	o	o	**	**
Acetone	o	o	***	o	***	o	*	o	o	o	***	***
Acetophenone	o	o	***	o	***	o	o	o	o	o	***	**
Acetyl Chloride	o	o	o	***	***	o	o	*	***	o	***	o
Acetylene	***	-	***	***	***	o	**	**	-	-	***	***
Acetylene Tetrabromide	o	o	***	***	***	-	**	-	-	-	***	-
Acrolein	*	-	***	*	***	o	-	-	-	o	***	**
Acrylonitrile	o	o	o	*	***	o	o	o	o	o	***	o
Adipic Acid	***	***	**	***	***	-	***	***	***	-	***	***
Adipic Acid	***	***	**	***	***	-	***	-	***	-	***	***
Aero Lubriplate	***	-	o	***	***	***	***	**	***	***	***	-
Aero safe 2300	o	-	***	o	***	o	o	o	*	o	-	-
Aero safe 2300 W	o	-	***	o	***	o	o	o	*	o	-	-
Aero Shell 1 AC Grease	***	***	o	***	***	***	**	***	***	***	***	o
Aero Shell 17 Grease	***	***	o	***	***	***	**	***	***	***	***	o
Aero Shell 7 A Grease	**	**	o	***	***	***	**	***	***	***	***	o
Aero Shell 750	**	**	o	***	***	**	o	o	**	o	***	o
Aero Shell Fluid 4	***	***	o	***	***	**	o	o	***	**	***	-
Aerozine 50 (50%Hydrazine,50% UDMH)	*	o	***	o	**	-	o	o	o	o	-	-
Air <95°C	**	**	***	***	***	***	***	***	***	***	***	***
95°C<Air<150°C	*	*	**	***	***	**	**	***	***	*	***	**
Air >150°C	o	o	o	**	***	o	o	***	**	o	**	o
Alcohol (Methanol - Methyl Alcohol)	***	***	***	o	***	o	***	***	***	o	***	***
Aluminium Acetate	**	**	***	o	***	o	**	o	o	o	***	***
Aluminium Bromide	***	***	***	***	***	***	***	***	***	o	***	***
Aluminium Chloride	***	***	***	***	***	***	**	***	**	*	***	***
Aluminium Fluoride	***	***	***	***	***	-	***	**	***	o	***	***
Aluminium Nitrate	***	***	***	***	***	o	***	**	-	*	***	***
Aluminium Phosphate	***	***	***	***	***	-	***	***	***	-	***	***
Aluminium Sulfate	***	***	***	***	***	o	***	***	***	o	***	***
Aluminium-Potassium Sulfate	***	-	***	***	***	o	***	**	-	o	***	***
Aluminum Chloride	***	***	***	***	***	***	**	***	**	*	***	***
Aluminum Hydroxide	**	-	***	**	***	o	***	***	**	o	***	***
Aluminum Sulfate	***	***	***	***	***	o	***	***	***	o	***	***
Ambrex 33 (Mobile)	***	***	o	***	***	***	**	o	*	**	***	-
Ambrex 830 (Mobile)	***	***	*	***	***	***	**	**	***	***	***	-
Ammonia (gas, cold)	***	***	***	o	***	o	***	***	o	o	***	***
Ammonia (gas, hot)	o	o	**	o	***	o	**	***	o	o	***	**
Ammonia, anhydrous	**	**	***	o	***	o	***	*	o	o	***	***
Ammoniac Sal	***	***	***	***	***	**	***	*	**	***	***	***

o : ne convient pas / not suitable \* Effet modéré à majeur / moderate to severe effect  
 \*\* Effet mineur à modéré / minor to moderate effect \*\*\* Convient / suitable

	NBR	HNBR	EPDM	FKM	FKM	ACM	CR	VMQ	FVMQ	AU	PTFE	IIR
Ammonium Acetate	***	***	***	***	***	**	***	*	**	***	***	***
Ammonium Carbonate Solution	o	o	***	***	***	o	***	-	-	o	***	***
Ammonium Chloride Solution	***	***	***	***	-	***	-	-	***	***	***	-
Ammonium Hydroxide	o	o	***	**	***	o	***	***	-	o	***	***
Ammonium Nitrate Solution	***	***	***	***	***	-	***	-	-	-	-	***
Ammonium Nitrite	***	***	***	-	***	-	***	**	-	-	-	***
Ammonium Phosphate	***	***	***	-	***	-	***	***	-	-	***	***
Ammonium Sulfate Solution	***	***	***	*	***	o	***	-	-	-	***	***
Amyl Acetate	o	o	*	o	***	o	o	o	o	o	***	*
Amyl Alcohol	**	**	***	**	***	o	**	o	***	o	***	***
Amyl Borate	***	***	o	***	***	-	***	-	-	-	***	o
Amyl Chloride	*	-	o	***	***	o	o	o	**	-	***	o
Amyl Chloronaphtalène	o	o	o	***	***	o	o	o	**	-	***	o
Amyl Naphthalene	o	o	o	***	***	*	o	o	**	o	***	o
Aniline	o	-	**	*	***	o	o	o	*	o	***	**
Aniline Dyes	o	o	**	**	***	o	**	*	**	o	***	**
Aniline Hydrochloride	**	-	**	**	***	o	o	o	**	o	***	**
Animal Fats	***	***	**	***	***	***	**	**	***	***	***	**
Aqua Regia (Nitric Acid/ Hydrochloric Acid)	o	o	*	**	***	o	o	o	*	o	***	o
Argon Gas	***	***	***	***	***	***	***	***	***	***	***	***
ASTM Test Fuel A	***	***	o	***	***	**	**	o	***	-	***	o
ASTM Test Fuel B	***	***	o	***	***	o	o	o	***	-	***	o
ASTM Test Fuel C	**	**	o	***	***	o	o	o	**	-	***	o
ASTM-Oil IRM 902	***	***	o	***	***	***	*	o	***	**	***	o
ASTM-Oil IRM 903	***	***	o	***	***	***	o	*	***	***	***	o
ASTM-Oil No.1	***	***	o	***	***	***	***	***	***	**	***	o
<b>B</b>												
Barium Chloride Solution	***	***	***	***	***	***	***	***	***	***	***	***
Barium Hydroxide Solution	***	***	***	***	***	o	***	***	***	o	***	***
Barium Sulfate	***	***	***	***	***	o	***	***	***	***	***	***
Barium Sulfide Solution	***	***	***	***	***	o	***	***	***	***	***	***
Beer	***	***	***	***	***	o	***	***	***	**	***	***
Beet Sugar Sap	***	**	***	***	***	o	**	***	***	o	***	***
Benzaldehyde	o	o	***	o	***	o	**	o	o	o	***	***
Benzenesulfonic Acid	o	o	*	***	**	o	**	o	**	-	***	o
Benzine (Ligroin)	***	***	o	***	***	***	**	o	***	**	***	o
Benzoic Acid, Solution	o	o	***	***	***	o	o	o	**	o	***	o
Benzene	o	o	o	***	***	o	o	o	*	o	***	o
Benzyl Alcohol	o	o	**	***	***	o	**	**	**	o	***	**
Benzyl Chloride	o	o	o	***	***	o	o	o	**	o	***	o
Biphenyl	o	o	o	***	***	o	o	o	**	o	***	o
Blast Furnace Gas	o	o	o	***	***	o	o	***	**	o	***	o
Bleach Solution	o	**	***	***	***	o	*	**	**	o	***	***
Borax (Sodium Borate)	**	***	***	***	***	**	*	**	**	***	***	***

o : ne convient pas / not suitable \* Effet modéré à majeur / moderate to severe effect  
 \*\* Effet mineur à modéré / minor to moderate effect \*\*\* Convient / suitable

	NBR	HNBR	EPDM	FKM	FFKM	ACM	CR	VMQ	FVMQ	AU	PTFE	IIR
Bordeaux Mixture	**	-	***	***	***	o	**	**	**	o	***	***
Boric Acid	***	***	***	***	***	o	***	***	***	***	***	***
Bromine	o	-	o	***	***	o	o	o	**	o	***	o
Bromine Water	o	-	**	***	***	o	o	o	**	o	***	*
Bromine Trifluoride	o	o	o	o	**	o	o	o	o	o	-	o
Bunker Oil	***	***	o	***	***	***	o	**	***	**	***	o
Butadiene	o	o	*	***	***	o	o	o	**	o	***	o
Butane	***	***	o	***	***	***	***	o	**	***	***	o
Butanol	***	***	**	***	***	o	***	**	***	o	***	**
Butene (Butylene)	**	-	o	***	***	o	*	o	**	o	***	o
Butter	***	***	***	***	***	***	**	**	***	***	***	**
Butyl Acetate	o	-	*	o	***	o	o	o	o	*	***	*
Butyl Alcohol	***	***	**	***	***	o	***	o	***	o	***	**
Butyl Carbitol	o	o	***	*	***	o	*	o	o	-	***	***
Butyl Cellosolve	*	o	**	o	***	o	*	-	o	o	***	**
Butyl Oleate	o	o	**	***	***	o	-	**	-	***	**	
Dibutyl Phthalate	o	*	**	*	***	o	o	**	*	*	***	*
Tertiary Butyl Catechol	o	-	**	***	***	o	**	-	***	o	***	**
Butyl Stearate	**	**	o	***	***	o	-	**	-	***	o	
Butyl Benzoate	o	o	**	***	***	o	o	-	***	-	***	**
Butylene	**	-	o	***	***	o	*	o	**	o	***	o
Dibutyl Ether	o	o	*	*	***	*	o	o	*	**	***	*
Butyraldehyde	o	-	**	o	***	o	o	o	o	o	***	**
Butyric Acid	o	o	**	**	***	o	o	o	o	o	***	**
C												
Calcium Acetate	**	**	***	o	***	o	**	o	o	o	***	***
Calcium Bisulfate	***	***	***	***	***	-	-	***	***	***	***	
Calcium Carbonate	***	***	***	***	***	*	***	***	-	o	***	***
Calcium Chloride	***	***	***	***	***	***	***	***	***	***	***	***
Calcium Cyanide	***	***	***	***	***	o	***	***	***	***	***	***
Calcium Hydroxide	***	***	***	***	***	o	***	*	***	***	***	***
Calcium Nitrate	***	***	***	***	***	*	***	**	***	***	***	***
Calcium Phosphate	***	***	***	***	***	***	**	***	***	***	***	***
Calcium Sulfate	***	***	***	***	***	-	***	***	***	***	***	***
Calcium Sulfide	**	***	***	***	***	o	***	**	***	***	***	***
Calcium Sulfite	***	***	***	***	***	o	***	***	***	***	***	***
Calcium Thiosulfate	**	**	***	***	***	o	***	***	***	***	***	***
Camphor	***	***	o	**	***	-	**	-	-	-	***	o
Cane Sugar Liquor	**	**	***	***	***	o	***	***	***	o	***	o
Carbitol	**	**	**	**	***	o	**	**	**	o	***	**
Carbolic Acid (Phenol)	o	o	**	***	***	o	o	o	***	-	***	**
Carbon Dioxide, dry	***	***	**	***	***	**	**	**	**	*	***	**
Carbon Dioxide, wet	***	***	**	***	***	**	**	**	**	*	***	**
Carbon Disulfide	o	o	o	***	***	*	o	*	*	-	***	o
Carbon Monoxide	***	***	**	***	***	***	*	***	**	-	***	**
Carbonic Acid	**	**	**	***	***	o	**	***	***	**	***	***
Castor Oil	***	***	***	***	***	***	***	***	***	***	***	**
Cellulose Acetate	o	o	**	*	***	o	o	-	-	***	***	-
Chloroacetic Acid	o	o	**	o	***	o	o	*	o	o	***	**
Chloric Acid	o	o	**	**	***	o	o	o	o	o	***	**

o : ne convient pas / not suitable    \* Effet modéré à majeur / moderate to severe effect  
 \*\* Effet mineur à modéré / minor to moderate effect    \*\*\* Convient / suitable

	NBR	HNBR	EPDM	FKM	FFKM	ACM	CR	VMQ	FVMQ	AU	PTFE	IIR
Chlorine Dioxide	o	o	*	**	***	o	o	*	**	-	***	*
Chlorine, Dry	o	*	o	***	***	o	o	o	***	o	***	o
Chlorine, Wet	o	*	o	***	***	o	*	*	**	o	***	o
Chloroacetic Acid	-	o	**	o	***	o	o	o	o	o	***	**
Chloroacetone	o	o	***	o	***	o	o	o	o	o	***	**
Chlorobenzene	o	o	o	**	***	o	o	o	**	o	***	o
Chlorobromomethane	o	o	**	**	***	o	o	o	**	o	***	**
Chlorobutadiene	o	o	o	**	***	o	o	o	**	o	***	o
Chloroform	o	o	o	**	***	o	o	o	**	o	***	o
Chloronaphthalene	o	o	o	***	***	o	o	o	**	o	***	o
(o)-Chlorophenol	o	o	o	***	***	o	o	o	**	o	***	o
Chlorosulfonic Acid	o	o	*	o	***	o	o	o	o	o	***	o
Chlorothene	o	o	o	**	***	o	o	o	**	-	***	o
Chlorotoluene	o	o	o	***	***	o	o	o	**	-	***	o
Chromic Acid	o	o	**	***	***	o	o	*	*	o	***	*
Citric Acid	***	***	***	***	***	*	***	***	***	o	***	***
Coal Tar	**	**	o	**	***	***	**	o	***	o	***	o
Cobalt Chlorite	***	***	***	***	***	*	***	**	***	**	***	***
Coconut Oil	***	***	o	***	***	***	*	***	***	**	***	*
Cod-liver Oil	***	***	*	***	***	***	**	**	***	***	***	***
Coffee	**	**	***	***	***	o	***	***	***	o	***	***
Coke Oven Gas	o	o	o	***	***	o	o	**	**	o	***	o
Copper Acetate Solution	**	**	**	o	***	o	**	o	o	o	***	***
Copper Chloride, Solution	***	***	***	***	***	o	**	***	***	**	***	***
Copper Cyanide	***	***	***	***	***	***	***	***	***	**	***	***
Corn Oil	***	***	*	***	***	**	*	**	***	***	***	*
Cottonseed Oil	***	***	*	***	***	***	*	**	***	***	***	*
Cresol	o	**	o	***	***	o	o	o	**	o	***	o
Crude Oil	**	**	o	***	***	***	o	o	**	***	***	o
Cumene	o	o	o	***	***	o	o	o	**	-	***	o
Cyclohexane	***	***	o	***	***	**	*	o	***	-	***	o
Cyclohexanol	**	**	o	***	***	o	**	o	***	-	***	o
Cyclohexanone	o	o	**	o	***	o	o	o	o	o	***	**
D												
Decalin (Decahydronaphthalene)	o	o	o	***	***	o	o	o	**	o	***	*
Decane	***	***	o	***	***	***	*	**	***	o	***	o
Dextrose	***	***	***	***	***	o	***	***	***	-	***	***
Di-Isobutyl Ketone	o	o	**	o	***	o	o	o	o	-	***	**
Di-Isobutylene	**	**	o	***	***	o	o	o	*	-	***	o
Di-Isopropyl Benzene	o	o	o	***	***	o	o	o	**	o	***	***
Di-Isopropyl Ketone	o	o	**	o	***	o	o	o	o	o	***	***
Diacetone	o	o	***	o	***	o	o	o	o	**	***	***
Diacetone Alcohol	o	o	***	o	***	o	o	o	o	o	***	***
Dibenzyl Sebacate	o	o	**	**	***	o	o	o	*	**	***	**
Dibenzylether	o	o	**	o	***	o	o	**	**	**	***	**
Dibromomethylbenzene	o	o	o	**	***	o	o	o	**	o	***	o
Dibutyl Ether	o	o	*	*	***	o	o	o	o	o	***	*
Dibutyl Phthalate	o	o	**	*	***	o	o	**	*	o	***	*
Dibutyl Sebacate	o	o	**	*	***	o	o	**	*	o	***	-
Dibutylamine	o	o	o	o	***	o	-	*	o	o	***	-

o : ne convient pas / not suitable    \* Effet modéré à majeur / moderate to severe effect  
 \*\* Effet mineur à modéré / minor to moderate effect    \*\*\* Convient / suitable

	NBR	HNBR	EPDM	FKM	FFKM	ACM	CR	VMQ	FVMQ	AU	PTFE	IIR
Dichloro Acetic Acid	o	o	**	o	***	o	o	o	-	o	***	*
Dichlorobutane	**	**	o	***	***	o	o	o	**	o	***	**
Dichloroethylene	o	o	o	**	***	-	o	o	*	o	***	**
Diesel Oil	***	***	o	**	***	o	o	o	***	*	***	o
Diethyl Ether	o	o	o	o	***	*	*	o	*	**	***	o
Diethyl Sebacate	**	*	**	**	***	o	o	**	**	o	***	**
Diethylene Glycol	***	***	***	***	***	**	***	**	***	o	***	***
Dimethyl Amine	o	o	o	o	***	o	o	o	o	o	***	o
Dimethyl Aniline	o	o	o	o	***	o	o	o	o	o	***	o
Dimethyl Ether	**	**	*	o	***	o	o	**	**	**	***	*
Dimethyl Formamide	**	**	*	o	***	o	o	**	o	**	***	*
Dimethyl Ketone	o	o	***	o	***	o	o	o	o	o	***	***
Dimethyl Phthalate	o	o	**	**	***	o	o	***	**	o	***	**
Dinitro Toluene	o	o	o	o	***	o	o	o	o	o	***	o
Diocetyl Phthalate	o	o	**	**	***	o	o	*	**	o	***	**
Diocetyl Sebacate	o	o	**	**	***	o	o	*	*	o	***	**
Dioxane	o	o	**	o	***	o	o	o	o	o	***	**
Dioxolane	o	o	**	o	***	o	o	o	o	o	***	*
Dipentene	**	**	o	***	***	o	o	o	o	o	***	o
Diphenyl	o	o	o	***	***	o	o	o	**	o	***	o
Divinylbenzene	o	o	o	**	***	o	o	o	*	o	***	o
Dodecanol	**	**	**	**	***	-	***	-	-	-	***	***
Dowtherm A	o	o	o	***	***	o	o	o	**	o	***	-
Dowtherm E	o	o	o	***	***	o	o	o	**	o	***	-

E

Epichlorhydrin	o	o	**	o	***	o	o	o	o	o	***	**
Ethane	***	***	o	***	***	***	**	o	**	*	***	o
Ethanol Amine	**	**	**	o	***	o	**	*	o	o	***	**
Ether	*	*	*	o	***	o	*	o	o	o	***	o
Ethyl Acetate	o	o	**	o	***	o	o	*	o	o	***	**
Ethyl Alcohol, Ethanol	**	**	***	*	***	o	***	*	***	o	***	***
Ethyl Benzene	o	o	o	**	***	o	o	o	**	o	***	o
Ethyl Bromide	**	**	o	***	***	o	o	o	***	o	***	o
Ethyl Cellulose	**	o	**	o	***	o	**	*	o	o	***	**
Ethyl Oxalate	o	o	***	***	***	o	o	o	**	***	***	***
Ethyl Pentachlorobenzene	o	o	o	***	***	o	o	o	**	o	***	o
Ethyl Sulfate (Diethyl Sulfate)	o	o	***	o	***	o	***	***	*	o	***	o
Ethyl acrylate	o	o	*	o	***	o	o	**	o	o	***	**
Ethyl chloride	**	**	**	**	***	o	**	o	***	o	***	**
Ethylene	***	***	**	***	***	**	*	o	***	**	***	**
Ethylene Bromide	o	o	o	**	***	o	o	o	*	o	***	o
Ethylene Chloride	o	o	o	**	***	o	*	o	*	-	***	o
Ethylene Chlorohydrin	o	o	**	**	***	o	**	o	**	o	***	**
Ethylene Diamine	**	**	***	o	***	o	*	*	o	o	***	***
Ethylene Dibromide	o	o	o	***	***	o	o	o	*	o	***	o
Ethylene Dichloride	o	o	o	***	***	o	o	o	*	o	***	o
Ethylene Glycol	**	**	***	***	***	*	*	*	***	**	***	o
Ethylene Oxide	o	o	*	o	***	o	o	o	o	o	***	*

o : ne convient pas / not suitable    \* Effet modéré à majeur / moderate to severe effect  
 \*\* Effet mineur à modéré / minor to moderate effect    \*\*\* Convient / suitable

	NBR	HNBR	EPDM	FKM	FFKM	ACM	CR	VMQ	FVMQ	AU	PTFE	IIR
Ethylene Trichloride	o	o	*	**	***	o	o	o	**	o	***	*

F

Fats (animal/vegetable)	***	***	*	***	***	***	**	**	***	**	***	**
Fatty Acids	**	**	o	***	***	-	**	***	***	***	***	*
Ferric Chloride	***	***	***	***	***	*	**	**	***	***	***	***
Ferric Nitrates	***	***	***	***	***	*	**	**	***	**	***	***
Ferric Sulfate	***	***	***	***	***	*	**	**	***	***	***	***
Fish Oil	***	***	o	***	***	***	*	***	***	**	***	o
Fluorine	o	o	o	*	**	o	*	o	*	-	***	*
Fluorobenzene	o	o	o	o	***	o	o	o	**	-	***	o
Formaldehyde	*	*	**	o	***	o	o	*	o	o	***	**
Formamide	*	**	**	*	***	-	o	-	-	o	***	**
Formic Acid	o	o	**	o	**	o	**	o	o	o	***	**
Freon 11	**	**	o	**	**	o	o	o	**	-	***	o
Freon 112	**	**	o	**	**	o	**	o	*	-	***	o
Freon 113	***	***	o	**	*	o	***	o	o	-	***	o
Freon 114	***	***	***	**	*	o	***	o	**	-	***	***
Freon 114 B2	**	**	o	**	*	o	***	o	**	-	***	-
Freon 115	***	***	***	**	*	o	***	o	o	-	***	***
Freon 12	***	***	**	**	**	***	o	*	-	***	**	**
Freon 13	***	***	***	**	***	o	***	o	*	-	***	***
Freon 13 B1	***	***	***	o	**	-	**	**	*	**	***	*
Freon 134 a	***	***	***	**	**	**	***	o	**	-	***	***
Freon 14	***	***	***	**	***	-	***	o	-	***	***	***
Freon 21	o	o	o	o	**	o	**	o	o	**	***	o
Freon 22	o	o	***	o	**	**	***	o	o	o	***	***
Freon 31	o	o	***	o	**	-	***	o	**	**	***	***
Freon 32	***	***	***	o	**	-	***	o	**	**	***	***
Freon BF	**	**	o	***	**	-	**	o	-	o	***	***
Freon C316	***	***	***	-	**	-	***	o	-	-	***	***
Freon C318	***	***	***	**	**	-	***	o	**	-	***	***
Freon MF	**	**	o	**	**	-	o	o	-	**	***	***
Freon PCA	***	***	o	**	**	-	***	o	-	***	***	o
Freon T-P35	***	***	***	***	**	-	***	***	-	***	***	***
Freon TA	***	***	***	o	**	-	***	***	-	***	***	***
Freon TC	***	***	**	***	**	-	***	o	-	***	***	***
Freon TMC	**	**	**	***	**	-	**	o	-	**	***	***
Freon TWD602	**	**	***	***	**	-	**	-	o	***	***	***
Fuel Oil	***	***	o	***	***	***	*	o	***	-	***	o
Fumaric Acid	***	***	**	***	***	o	**	**	***	-	***	o
Furan	o	o	o	o	***	o	o	o	o	o	***	*
Furfural (Furfuryl Aldehyde)	*	*	**	o	**	o	o	o	o	*	***	**
Furfuryl Alcohol	o	o	**	o	***	o	o	o	o	*	***	**

G

Gallic Acid	**	**	**	***	***	o	*	*	***	o	***	**
Gasoline/Alcohol Mix	**	*	o	***	***	o	o	o	***	o	***	o
Gelatin	***	***	***	***	***	o	***	***	***	o	***	***
Glauber's Salt	o	o	**	***	***	o	**	-	***	o	***	**
Glucose	***	***	***	***	***	o	***	***	***	o	***	***

o : ne convient pas / not suitable    \* Effet modéré à majeur / moderate to severe effect  
 \*\* Effet mineur à modéré / minor to moderate effect    \*\*\* Convient / suitable

	NBR	HNBR	EPDM	FKM	FFKM	ACM	CR	VMQ	FVMQ	AU	PTFE	IIR
Glycerin (Glycerol)	***	***	**	***	***	*	***	***	***	o	***	***
Glycerol	***	***	**	***	***	*	***	***	***	o	***	***
Glycerol Triacetate (Triacetin)	**	**	***	o	***	o	**	**	o	o	***	***
Glycine	**	**	***	***	***	o	***	o	o	o	***	***
Glycolic Acid	o	***	**	***	***	o	**	***	***	o	***	***
<b>H</b>												
HEF-2	**	**	o	***	***	*	o	o	**	o	***	o
Helium	***	***	***	***	***	***	***	***	***	***	***	***
Heptane	***	***	o	***	***	***	**	o	***	**	***	o
Hexachloro Butadiene	***	***	o	***	***	o	o	o	o	*	***	o
Hexadecane	***	***	o	***	***	***	**	o	*	o	***	o
Hexaldehyde	o	o	***	o	***	o	*	**	o	o	***	**
Hexalin (Cyclohexanol)	**	**	o	***	***	o	**	o	***	*	***	o
Hexane	***	**	o	***	***	***	**	o	***	**	***	o
Hexene	**	**	o	***	***	***	**	o	***	**	***	o
Hexyl Alcohol	***	***	**	***	***	o	***	***	***	o	***	***
Hydrazine	**	**	***	*	***	*	**	**	o	o	***	***
Hydrobromic Acid	o	o	***	***	***	o	*	o	*	o	***	***
37% Hydrochloric Acid (Muriatic Acid)	*	*	***	***	***	*	*	o	**	*	***	***
Hydrocyanic Acid	**	**	***	***	***	o	**	*	**	-	***	***
Hydrofluoric Acid, Anhydrous	o	o	o	*	***	o	o	o	o	o	***	-
Hydrofluoric Acid, concentrated	o	o	o	*	***	*	*	o	o	o	***	**
Hydrofluoric Acid	**	**	**	***	***	o	**	o	o	*	***	***
Hydrogen Chloride	o	o	***	***	***	-	o	o	o	-	***	***
Hydrogen Fluoride	o	o	***	**	***	o	o	o	o	o	***	o
Hydrogen Peroxide	**	**	o	***	***	o	***	**	**	o	***	***
Hydrogen Sulfide	o	*	***	*	***	o	**	*	*	-	***	***
Hydrogen	***	***	***	***	***	-	-	*	*	***	***	-
Hydrogen Sulfide	o	*	***	*	***	o	**	*	*	**	***	***
Hydroquinone	*	*	o	*	***	o	o	*	**	*	***	o
Hydroxy Acetic Acid	***	**	**	***	***	o	**	*	***	o	***	***
Hypochlorous Acid	o	o	**	*	***	o	o	-	-	-	***	**
<b>I</b>												
Iodine	**	**	**	***	***	o	o	*	***	o	***	**
Iodine pentafluoride	o	o	o	o	**	o	o	o	o	o	***	o
Iso-Butyl Alcohol	**	**	***	**	***	o	***	***	**	o	***	***
Iso-Butylaldehyde	*	*	**	o	**	o	o	o	o	o	***	-
Iso-Butyl Methyl Ketone	o	o	*	o	***	o	o	o	o	o	***	*
Iso-Dodecane	***	***	o	***	***	o	**	o	***	***	***	o
Iso-Octane	***	***	o	***	***	**	**	o	***	**	***	o
Iso-Pentane	***	***	o	***	***	**	o	o	***	**	***	o
Iso-Propyl-Acetate	o	o	**	o	***	o	o	o	o	o	***	**
Iso-Propyl-Alcohol	**	**	***	***	***	o	**	***	**	o	***	***
Iso-Propyl-Benzene	o	o	o	***	***	o	o	o	**	o	***	o
Iso-Propyl-Chloride	o	o	o	***	***	o	o	o	**	o	***	o
Iso-Propyl-Ether	*	*	o	o	***	*	*	*	*	o	***	o

o : ne convient pas / not suitable    \* Effet modéré à majeur / moderate to severe effect  
 \*\* Effet mineur à modéré / minor to moderate effect    \*\*\* Convient / suitable

	NBR	HNBR	EPDM	FKM	FFKM	ACM	CR	VMQ	FVMQ	AU	PTFE	IIR
<b>K</b>												
Kerosene	***	**	o	***	***	**	*	o	***	**	***	o
<b>L</b>												
Lactams	o	o	**	**	***	o	**	o	o	-	***	**
Lactic Acid	***	***	***	***	***	o	***	**	***	-	***	***
Lavender Oil	**	*	o	***	***	**	o	o	**	o	***	o
Lead Acetate	*	**	***	o	***	o	**	o	o	o	***	***
Lead Nitrate	***	***	***	***	***	o	***	o	***	o	***	***
Ligroin	***	***	o	***	***	***	**	o	***	**	***	o
Lindol	o	o	***	**	***	o	o	*	*	o	***	***
Linoleic Acid	**	**	o	**	***	o	*	**	**	**	***	o
Linseed Oil	***	***	*	***	***	**	***	***	***	-	***	*
Lithium Bromide Brine	***	***	***	***	***	-	**	***	***	-	***	***
Lithium Chloride	***	***	***	***	***	-	**	***	***	-	***	***
<b>M</b>												
Magnesium Acetate	o	o	***	o	***	o	o	o	o	-	***	**
Magnesium Chloride	***	***	***	***	***	o	**	***	***	-	***	***
Magnesium Hydroxide	**	**	***	**	***	o	**	*	**	-	***	***
Magnesium Salts	***	***	***	***	***	***	***	***	***	***	***	***
Magnesium Sulfate	***	***	***	***	***	o	**	***	***	o	***	***
Maleic Acid	o	o	o	***	***	o	o	*	**	*	***	o
Maleic Anhydride	o	o	o	**	***	o	o	-	-	-	***	o
Malic Acid	***	***	o	***	***	o	**	**	***	o	***	o
Mercuric Chloride Solution	***	***	***	***	***	-	**	*	***	-	***	***
Mercury	***	***	***	***	***	***	***	**	***	**	***	***
Mesityl Oxide	o	o	**	o	***	o	o	o	o	o	***	**
Methacrylic Acid	o	o	**	*	***	-	**	o	o	o	***	-
Methane	***	***	o	***	***	**	**	o	**	o	***	o
Methanol	**	**	***	**	***	o	***	**	**	o	***	***
Methyl Acetate	o	o	**	o	***	o	*	o	o	o	***	**
Methyl Acetoacetate	o	o	**	o	***	o	o	*	o	o	***	**
Methyl Acrylate	o	o	**	o	***	o	**	o	o	o	***	**
Methyl Alcohol	**	***	***	**	***	o	***	**	**	o	***	***
Methyl Amine	o	o	**	o	***	o	**	o	-	o	***	***
Methyl Bromide	**	**	o	***	***	o	o	*	***	o	***	o
Methyl Butyl Ketone	o	o	**	o	***	o	o	o	o	o	***	**
Methyl Carbonate	o	o	o	**	***	o	o	o	**	o	***	o
Methyl Cellosolve	o	o	**	o	***	o	o	o	o	o	***	**
Methyl Cellulose	**	**	**	**	***	o	**	**	o	**	***	**
Methyl Chloride	o	o	*	**	***	o	o	o	**	o	***	*
Methyl Cyclopentane	o	o	o	**	***	o	o	o	**	o	***	o
Methyl Ethyl Ketone	o	o	**	o	***	o	o	o	o	o	***	**
Methyl Formate	o	o	**	*	***	o	**	*	o	-	***	**
Methyl Glycol Acetate (Ethylene Glycol)	o	o	***	o	***	o	*	**	-	o	***	**
Methyl Iso-Butyl Ketone	o	o	*	o	***	o	o	o	o	o	***	*
Methyl Iso-Propyl Ketone	o	o	**	o	***	o	o	o	o	o	***	**
Methyl Methacrylate	o	o	*	o	***	o	o	o	o	o	***	*

o : ne convient pas / not suitable    \* Effet modéré à majeur / moderate to severe effect  
 \*\* Effet mineur à modéré / minor to moderate effect    \*\*\* Convient / suitable

	NBR	HNBR	EPDM	FKM	FKM	ACM	CR	VMQ	FVMQ	AU	PTFE	IIR
Methyl Oleate	o	o	**	***	***	o	o	*	**	-	***	**
Methyl Phenyl Ether (Anisole)	o	o	-	*	***	-	o	o	o	o	***	-
Methyl Salicylate	o	o	**	**	***	o	o	*	o	-	***	**
Methylene Chloride	o	o	o	**	***	o	o	o	**	o	***	o
Milk	***	***	**	***	***	-	***	***	***	**	***	-
Mineral Oil	***	***	*	***	***	***	**	**	***	***	***	*
Monobromobenzene	o	o	o	**	***	o	o	o	**	*	***	o
Monochloroacetic Acid	o	o	**	o	***	o	o	o	o	*	***	*
Monochlorobenzene	o	o	o	**	***	o	o	o	**	*	***	o
Monoethanol Amine	o	o	**	o	***	o	o	**	o	o	***	**
Morpholine	o	o	**	***	***	o	**	o	o	-	***	**

**N**

Naphtha	**	**	o	***	***	**	o	o	**	-	***	o
Naphthalene	o	o	o	***	***	o	o	o	**	-	***	-
Naphthenic Acid	**	*	o	***	***	o	o	o	***	-	***	o
Natural Gas	***	***	o	***	***	**	**	o	**	**	***	o
Neats Foot Oil	***	***	**	***	***	***	o	**	***	**	***	**
Neon Gas	***	***	***	***	***	***	***	***	***	***	***	***
Nickel Acetate	*	**	***	o	***	o	**	o	o	o	***	***
Nickel Chloride	***	***	***	***	***	*	**	***	***	*	***	***
Nickel Nitrate	***	***	***	***	***	-	***	***	-	-	***	***
Nickel Sulfate	***	***	***	***	***	o	**	***	***	*	***	***
Nitric Acid, concentrated	o	o	o	**	***	o	o	o	*	o	***	***
Nitric Acid, fuming	o	o	o	*	**	o	o	o	o	o	***	**
Nitrobenzene	o	o	o	**	***	o	o	o	o	o	***	o
Nitro Methane	o	o	*	o	***	o	*	o	o	o	***	**
Nitro Propane	o	o	**	o	***	o	o	o	o	***	***	**
Nitrogen Gas	***	***	***	***	***	***	***	***	***	-	***	***
Nitrogen Tetroxide	o	o	o	o	***	o	o	o	o	-	***	*

**O**

Octadecane	***	***	o	***	***	**	**	o	***	-	***	o
Octane	**	**	o	***	***	o	o	o	**	**	***	o
Octanol (Octyl Alcohol)	**	**	***	***	***	o	**	**	**	o	***	**
Octyl Acetate	o	o	o	o	***	-	-	-	-	-	***	**
Oil of Turpentine	***	***	o	***	***	**	o	o	**	-	***	-
Olefin, crude	***	***	o	***	***	**	-	*	**	***	***	o
Oleic Acid	*	o	o	***	***	o	o	o	**	-	***	o
Oleum (Sulfuric Acid, 0 to 50%)	o	*	o	**	***	o	o	o	o	o	***	o
Olive Oil	***	***	**	***	***	***	**	**	***	o	***	**
Oxalic Acid	**	**	***	***	***	o	**	**	***	-	***	***
Ozone	o	**	***	***	***	**	*	***	**	***	***	**

**P**

Palmitic Acid	**	***	**	***	***	o	**	o	***	o	***	**
Para Dichloro Benzene	o	o	o	***	***	o	o	o	**	o	***	**
Paraffin	***	***	o	***	***	***	***	**	***	**	***	o
Peanut Oil	***	***	o	***	***	***	*	**	***	***	***	o
Penta Chloro Diphenyl	o	o	o	*	***	o	o	o	o	o	***	*
Pentane	***	***	o	***	***	***	**	o	o	o	***	o

o : ne convient pas / not suitable    \* Effet modéré à majeur / moderate to severe effect  
 \*\* Effet mineur à modéré / minor to moderate effect    \*\*\* Convient / suitable

	NBR	HNBR	EPDM	FKM	FKM	ACM	CR	VMQ	FVMQ	AU	PTFE	IIR
Pentanol	**	**	***	**	***	o	**	o	***	o	***	***
Perchloric Acid	o	o	**	***	***	o	**	o	**	o	***	**
Perchloro Ethylene	o	o	o	***	***	o	o	o	**	o	***	o
Petroleum	***	***	o	***	***	*	**	o	***	**	***	o
Phenol	o	o	**	***	***	o	o	o	***	o	***	**
Phenyl Benzene	o	o	o	**	***	o	o	o	**	o	***	o
Phenyl Ether	o	o	o	o	***	o	o	*	**	o	***	o
Phenyl Hydrazine	o	o	o	***	***	o	o	*	**	o	***	o
Phosphoric Acid 20%	o	o	**	**	***	-	o	*	**	***	***	-
Phosphorus Trichloride	o	o	***	***	***	o	-	o	***	o	***	-
Photographic Developing Bath	***	***	**	***	***	-	***	***	***	**	***	***
Phthalic Acid	*	*	**	**	***	-	**	-	-	-	***	***
Phthalic Anhydride	***	-	***	o	***	-	o	-	-	-	***	-
Picric Acid, Aqueous Solution	**	**	***	**	***	o	**	o	**	-	***	***
Pine Oil	o	**	o	*	***	o	***	o	***	-	***	o
Piperidine	o	o	o	o	***	o	o	o	o	-	***	o
Potassium Acetate	**	o	***	o	***	o	**	o	o	o	***	***
Potassium Aluminium Sulfate	***	***	***	***	***	o	***	***	o	**	***	***
Potassium Bicarbonate	***	***	***	***	***	o	***	**	***	-	***	-
Potassium Bisulfate	***	***	***	***	***	o	**	**	**	-	***	***
Potassium Bisulfite	***	***	***	***	***	*	***	**	**	-	***	***
Potassium Bromide	***	***	***	***	***	o	**	***	***	-	***	***
Potassium Carbonate	***	***	***	***	***	*	***	***	***	-	***	***
Potassium Chlorate	o	***	***	***	***	o	**	-	-	-	***	***
Potassium Chloride	***	***	***	***	***	*	***	***	***	***	***	***
Potassium Chromate	***	***	***	***	***	*	***	-	-	***	***	***
Potassium Cyanide	***	***	***	***	***	*	**	***	***	o	***	***
Potassium Dichromate	***	***	***	***	***	*	**	**	o	*	***	***
Potassium Hydroxide	**	**	***	o	***	o	**	*	*	*	***	-
Potassium Iodide	***	***	***	***	***	o	**	***	***	o	***	***
Potassium Nitrate	**	**	***	***	***	*	**	***	***	**	***	***
Potassium Perchlorate	**	**	***	***	***	o	**	***	***	o	***	***
Potassium Persulfate	o	*	***	***	***	o	**	***	***	o	***	***
Potassium Phosphate	***	***	***	***	***	-	***	-	-	o	***	-
Potassium Sulfate	***	***	***	***	***	o	**	***	***	**	***	***
Potassium Sulfite	**	***	***	***	***	o	**	***	***	**	***	***
Propane	***	***	o	***	***	**	**	o	**	**	***	o
Propanol	**	***	***	***	***	o	***	**	***	o	***	***
Propionic Acid	*	*	***	***	***	-	*	o	o	o	***	***
Propyl Acetate	o	o	**	o	***	o	o	o	o	o	***	**
Propyl Acetone	o	o	***	o	***	o	o	o	o	o	***	***
Propyl Nitrate	o	o	**	o	***	o	o	o	o	o	***	**
Propylene	o	o	o	***	***	o	o	o	**	o	***	o
Propylene Dichloride	o	o	o	***	***	-	o	-	-	-	***	o
Propylene Glycol	***	***	***	**	***	-	**	-	-	o	***	***
Propylene Oxide	o	o	**	*	***	o	o	o	o	o	***	**
Pyridine	o	o	**	o	***	o	o	o	o	o	***	**
Pyrrole	o	o	*	o	***	o	o	*	o	o	***	o

**R**

o : ne convient pas / not suitable    \* Effet modéré à majeur / moderate to severe effect  
 \*\* Effet mineur à modéré / minor to moderate effect    \*\*\* Convient / suitable



	NBR	HNBR	EPDM	FKM	FFKM	ACM	CR	VMQ	FVMQ	AU	PTFE	IIR
Rapeseed Oil	***	***	**	***	***	***	*	*	**	**	***	o
<b>S</b>												
Salicylic Acid	***	***	***	***	***	o	***	***	***	***	***	***
Salt Water	***	***	***	***	***	o	**	***	***	o	***	***
Sewage	***	***	***	***	***	o	**	***	***	-	***	***
Silicone grease	***	***	***	***	***	***	**	o	***	***	***	***
Silicone Oil	***	***	***	***	***	***	***	o	**	***	***	***
Silver Nitrate	***	***	***	***	***	*	***	***	***	-	***	***
Skydrol 500	o	o	***	o	***	o	o	o	o	o	***	**
Skydrol 7000	o	o	***	**	***	o	o	o	o	o	***	***
Soap Solution	***	***	***	***	***	o	**	***	***	**	***	***
Sodium Acetate	**	o	***	o	***	o	**	o	o	o	***	***
Sodium Benzoate	***	***	***	***	***	o	**	***	***	o	***	***
Sodium Bicarbonate	***	***	***	***	***	o	***	***	***	o	***	***
Sodium Bisulfate	***	***	***	***	***	o	***	***	***	o	***	***
Sodium Bisulfite	***	***	***	***	***	o	o	***	***	o	***	***
Sodium Borate (Borax)	**	**	***	***	***	o	***	**	**	o	***	***
Sodium Carbonate (Soda Ash)	***	***	***	***	***	o	***	***	***	o	***	***
Sodium Chlorate	**	***	***	***	***	o	***	***	***	**	***	***
Sodium Chloride	***	***	***	***	***	o	***	***	***	-	***	***
Sodium Chlorite	o	o	***	***	***	o	o	-	***	-	***	***
Sodium Cyanide Solution	***	***	***	**	***	o	***	***	***	-	***	***
Sodium Dichromate	***	***	***	***	***	o	***	***	***	o	***	***
Sodium Fluoride	***	***	***	***	***	o	***	**	***	**	***	***
Sodium Hydroxide	***	**	***	*	***	o	**	***	***	*	***	***
Sodium Hypochlorite	**	**	**	***	***	o	**	**	**	o	***	***
Sodium Nitrate	**	***	***	***	***	o	**	o	***	o	***	***
Sodium Nitrite	**	**	***	***	***	o	**	o	***	o	***	***
Sodium Peroxide	**	**	***	***	***	o	**	o	***	o	***	***
Sodium Silicate	*	***	***	***	***	o	***	o	***	-	***	***
Sodium Sulfide	**	***	***	***	***	o	**	***	**	o	***	***
Sodium Sulfite	***	***	***	***	***	o	***	***	***	o	***	***
Sodium Thiosulfate (Antichlor)	**	***	***	***	***	o	***	***	***	-	***	***
Soy Bean Oil	***	***	*	***	***	**	*	***	***	**	***	*
Stannic Chloride	***	***	***	***	***	o	*	**	***	-	***	***
Starch	***	***	***	***	***	o	*	***	***	**	***	**
Stearic Acid	*	**	*	**	***	o	**	*	**	***	***	*
Stoddard Solvent	***	***	o	***	***	***	**	o	***	***	***	o
Styrene	o	o	o	**	***	o	o	o	*	-	***	o
Succinic Acid	***	***	***	***	***	o	**	***	***	o	***	***
Sucrose Solution	***	***	***	***	***	o	**	***	***	o	***	***
Sulfur	o	o	***	***	***	o	***	**	***	o	***	***
Sulfur Chloride	o	o	o	***	***	o	o	o	**	o	***	o
Sulfur Dioxide (dry)	o	*	***	o	***	o	o	**	**	o	***	**
Sulfur Dioxide (wet)	o	*	***	o	***	o	o	**	**	-	***	***
Sulfur Hexafluoride (SF6)	**	**	***	**	***	o	***	**	**	-	***	***
Sulfuric Acid (3 molar)	o	o	**	***	***	*	*	o	o	o	***	*
Sulfuric Acid (concentrated)	o	o	o	**	***	o	o	o	o	o	***	o
Sulfuric Acid fuming	o	o	o	**	***	o	o	o	o	o	***	o

o : ne convient pas / not suitable    \* Effet modéré à majeur / moderate to severe effect  
 \*\* Effet mineur à modéré / minor to moderate effect    \*\*\* Convient / suitable

	NBR	HNBR	EPDM	FKM	FFKM	ACM	CR	VMQ	FVMQ	AU	PTFE	IIR
Sulfurous Acid	**	**	**	***	***	o	**	o	o	-	***	o
<b>T</b>												
Tallow	***	***	**	***	***	**	**	**	***	**	***	**
Tar	**	**	o	**	***	o	o	**	**	o	***	o
Tartaric Acid	***	***	**	***	***	o	**	***	***	o	***	**
Tetrachloroethane	o	o	o	**	***	o	o	o	**	o	***	o
Tetrachloroethylene	o	o	o	***	***	o	o	o	**	o	***	o
Tetrachloromethane	o	o	o	***	***	o	o	o	**	o	***	o
Tetraethyl Lead	**	**	o	***	***	o	o	o	**	o	***	o
Tetrahydrofuran	o	o	o	***	***	o	o	o	o	o	***	*
Thionyl Chloride	o	o	o	***	***	o	o	o	o	o	***	o
Thiophene	o	o	o	***	***	o	o	o	o	o	***	o
Titanium Tetrachloride	*	**	o	**	***	o	o	o	**	o	***	o
Toluene (Toluol)	o	*	o	**	***	o	o	o	**	o	***	o
Transformer Oil	**	**	o	***	***	**	o	**	***	***	***	o
Triacetin (Glycerine Triacetate)	**	**	***	o	***	o	**	**	o	o	***	***
Triaryl Phosphate	o	o	***	***	***	o	o	*	**	o	***	**
Tributoxy Ethyl Phosphate	o	o	**	**	***	o	o	*	**	-	***	***
Tributyl Marcaptane	o	o	o	***	***	o	o	o	*	-	***	o
Tributyl Phosphate	o	o	**	o	***	o	o	*	o	o	***	**
Trichloroacetic Acid	**	**	**	o	***	o	o	*	*	o	***	**
Trichloro Benzene	o	o	o	**	***	o	o	o	*	o	***	o
Trichloro Ethane	o	o	o	***	***	o	o	o	**	o	***	o
Trichloro Ethylene	o	o	o	**	***	o	o	o	**	o	***	o
Tricresyl Phosphate	o	o	**	**	***	o	o	o	**	o	***	**
Triethanol Amine	*	*	**	o	***	o	**	o	*	o	***	**
Triethyl Borane	o	o	*	***	***	o	o	-	-	-	***	*
Triethylene Glycol	***	***	***	***	***	*	**	***	-	-	***	***
Trifluoro Ethane	o	o	o	**	***	o	o	o	**	o	***	o
Trinitrotoluene (TNT)	o	o	o	**	***	o	**	*	**	**	***	o
Trioctyl Phosphate	o	o	***	**	***	o	o	*	**	o	***	***
Turpentine	***	***	o	***	***	**	o	o	**	*	***	o
<b>U</b>												
Urea	***	***	***	***	***	**	**	***	***	o	***	***
<b>V</b>												
Vaseline	***	***	o	***	***	**	**	**	***	**	***	-
Vaseline Oil	***	***	o	***	***	o	**	**	**	o	***	-
Vegetable Oils & Fats	***	***	o	***	***	**	*	**	***	**	***	*
Vinegar	**	**	***	**	***	o	**	***	**	o	***	***
Vinyl Acetate	o	o	**	o	***	o	**	-	**	-	***	**
Vinyl Chloride, liquid	o	o	*	**	***	o	o	o	**	-	***	*
<b>W</b>												
Waste Gas (cont. Carbon Dioxide)	***	***	**	***	***	***	**	**	***	***	***	**
Waste Gas (cont. Carbon Monoxide)	***	***	***	***	***	***	**	***	**	***	***	***
Waste Gas (cont. Sulfur Dioxide)	o	o	***	**	***	o	o	**	**	-	***	**
Water steam >+150 °C/+302 °F	o	o	*	o	***	o	o	o	o	o	***	o

o : ne convient pas / not suitable    \* Effet modéré à majeur / moderate to severe effect  
 \*\* Effet mineur à modéré / minor to moderate effect    \*\*\* Convient / suitable

	NBR	HNBR	EPDM	FKM	FFKM	ACM	CR	VMQ	FVMQ	AU	PTFE	IIR
Water steam < +150 °C/+302 °F	o	**	***	o	***	o	*	*	o	o	***	***
Water to +80 °C/+176 °F	***	***	***	***	***	o	**	***	***	o	***	***
Water to +135 °C/+275 °F	*	***	***	***	***	o	*	**	***	o	***	-
Wine & Whiskey	***	***	***	***	***	-	***	***	***	o	***	-
Wood Oil	***	***	o	***	***	***	**	o	**	o	***	*
<b>X</b>												
Xenon	***	***	***	***	***	***	***	***	***	***	***	***
Xylene (Xylol)	o	o	o	**	***	o	o	o	***	o	***	o
Xylidines (aromatic Amines)	o	*	o	o	***	o	o	o	o	o	***	o
<b>Z</b>												
Zeolites	***	***	***	***	***	***	***	***	***	***	***	***
Zinc Acetate	*	**	***	o	***	o	**	o	o	o	***	***
Zinc Chloride Solutions	***	***	***	***	***	o	***	***	***	o	***	***
Zinc Sulfate	***	***	***	***	***	o	***	***	***	o	***	***

o : ne convient pas / not suitable      \* Effet modéré à majeur / moderate to severe effect  
 \*\* Effet mineur à modéré / minor to moderate effect      \*\*\* Convient / suitable

# Index

## B

### BACKUP RING (BAE)

Definition & materials	84
Dimensions	86

### BONDED SEAL

Definition & material	100
Self-centering TBS range	102
TBS range	106

## C

### CLAMP GASKET

Definition & materials	108
Dimensions	110
PTFE envelope clamp	109

### COATINGS

Summary table	56
T-coat®	54
T-color®	52
T-Lub®	53
T-surf®	51

### CONTROL

100% visual inspection	16
AQL Visual Inspection	15
Automatic sorting	16
Mass production	14
Prototype	14
Scanning	14

### CUTTING

Process	11
---------	----

## D

### DEFLASHING

Characteristics	11
-----------------	----

### D-RING

Definition & material	114
D-ring range	114 - 116
Flanged D-ring range	114

## H

### HARDNESS

IRHD	27
SHORE A	27

### HOMOLOGATION

Main certifications	44
Main standard org.	41
Techné certifications	42

## J

### JR SEAL

Characteristics	96-97
-----------------	-------

### JT4 SEAL

Definition & materials	78
Dimensions & Tolerances	79
Groove sizing	81 - 82

## M

### MACHINING

Turning	12
---------	----

### MATERIAL

CR	39
EPDM	36
FFKM	38
FKM	37
FVMQ	38
HNBR	35
IIR	39
NBR	35
PTFE	40
Storage	34
TPU	40
VMQ	38

### MATERIAL PROPERTIES

Ageing resistance	32
Basic principles	26
Compression set	30
Hardness	27
Specific gravity	28
Temperature resistance	29
Tensile strength	31

### MOLDING

Compression	7
Injection	6
Tolerance	9
Transfer moulding	8

## O

### O-RING

Chamfers and radii	73
Definition & material	60
Dimensions & tolerances	62
FEP	64
Mounting	74
Precision O-ring	65
Specific groove	72
Standard groove	66

## P

### PACKAGING

Characteristics	16
-----------------	----

## Q

### QUALITY

Documents	21
Means	14

## R

### RUBBER CORD

Characteristics	92
-----------------	----

## S

### SMS

Characteristics	116
-----------------	-----

### STANDARD

BS 4825-3 (Clamp)	108
BS 4825 (Clamp)	108
DIN 1149 (SMS)	118
DIN 3852 (JR)	96
DIN 3869 (JR)	96
DIN 11850 (Clamp)	108, 118
DIN 11851 (D-ring)	114
DIN 32676 (Clamp)	108
ISO 1127 (Clamp)	108
ISO 1179-2 :2008 (JR)	96
ISO 2852 (Clamp)	108
ISO 9974-2 : 2000 (JR)	96
SMS 3008 (Clamp)	108
SMS 3017 (Clamp)	108

## T

### TECHNÉ DESIGN

Design sheet	19
Feasibility study	18

# Definition sheet

## ✓ Your References

Compagny :.....  
 Address : .....  
 Contact (Mr/Mrs) : .....  
 Dpt :.....  
 Phone :.....  
 Mail :.....

## ✓ Attached files

Specification sheet   
 Drawing / sketch   
 3D CAD file (\*.step, centered tolerances, ±)   
 Assembly parts

## ✓ Your request is on

O-Ring	<input type="checkbox"/>	Triclover clamp Seal	<input type="checkbox"/>
Precision O-Ring	<input type="checkbox"/>	D-Ring milk coupling Seal	<input type="checkbox"/>
FEP	<input type="checkbox"/>	SMS Seal	<input type="checkbox"/>
JT4 X-Ring	<input type="checkbox"/>	Oil Seal	<input type="checkbox"/>
Backup Ring (BAE)	<input type="checkbox"/>	Machined part	<input type="checkbox"/>
Rubber Cord	<input type="checkbox"/>	Cut gasket	<input type="checkbox"/>
JR Seal	<input type="checkbox"/>	Moulded part	<input type="checkbox"/>
Bonded Seal	<input type="checkbox"/>	Part on drawing	<input type="checkbox"/>

## ✓ For PPAP

Cover page according to VDA	<input type="checkbox"/>	Material data sheet	<input type="checkbox"/>
Dimensional measurements	<input type="checkbox"/>	Declaration IMDS (International Material Data System)	<input type="checkbox"/>
Material checking	<input type="checkbox"/>	TPD sheet (Transport Packaging Description)	<input type="checkbox"/>
Drawing	<input type="checkbox"/>	Certificate 2.1	<input type="checkbox"/>
Process FMEA	<input type="checkbox"/>	Certificate 2.2	<input type="checkbox"/>
Production flowchart	<input type="checkbox"/>	Certificate 3.2	<input type="checkbox"/>
Control plan	<input type="checkbox"/>	Summary of Capabilities	<input type="checkbox"/>
Process capabilities	<input type="checkbox"/>	Security plan	<input type="checkbox"/>
List of inspection tools	<input type="checkbox"/>	Tool picture	<input type="checkbox"/>
R&R (repeatability & reproducibility)	<input type="checkbox"/>		
Safety Data sheet	<input type="checkbox"/>		

*For more informations see page 21*

## ✓ Contacts

### OEM

Phone : +33 (0)4 78 43 12 72  
 Fax : +33 (0)4 78 43 12 77  
 Mail : oem@techne.fr

### Distribution

Phone : +33 (0)4 78 43 12 70  
 Fax : +33 (0)4 78 43 11 43  
 Mail : distribution@techne.fr

### Techné Shanghai

Phone : +86 21 64 73 84 17  
 Fax : +86 21 64 73 84 39  
 Mail : techneshanghai@techne.cn

### Industrie

Phone : +33 (0)4 78 43 78 78  
 Fax : +33 (0)4 78 43 16 91  
 Mail : industrie@techne.fr

### Chromex

Phone : +33 (0)1 69 92 16 30  
 Fax : +33 (0)1 64 94 84 02  
 Mail : chromex@chromex.info

### Techné Turquie

Phone : +90 (0) 212 256 68 96  
 Fax : +90 (0) 212 255 58 15  
 Mail : turkey@techne.fr







Techné  
About us

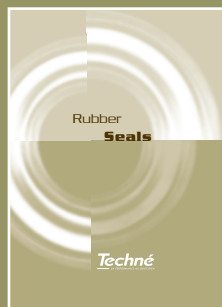

Rubber  
Seals

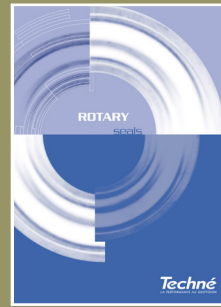

Rotary  
Seals



Surface  
Treatments



Aseptic  
Seals



Machined Parts



Hydraulic  
Seals



Cut  
Gaskets

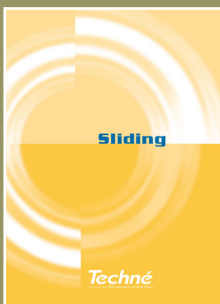

Sliding

# Techné

G R O U P E

## OEM

Phone : +33 (0)4 78 43 12 72  
Fax : +33 (0)4 78 43 12 77  
Mail : oem@techne.fr

## Industrie

Phone : +33 (0)4 78 43 78 78  
Fax : +33 (0)4 78 43 16 91  
Mail : industrie@techne.fr

## Distribution

Phone : +33 (0)4 78 43 12 70  
Fax : +33 (0)4 78 43 11 43  
Mail : distribution@techne.fr

## Chromex

Phone : +33 (0)1 69 92 16 30  
Fax : +33 (0)1 64 94 84 02  
Mail : chromex@chromex.info

## Techné Shanghai

Phone : +86 21 64 73 84 17  
Fax : +86 21 64 73 84 39  
Mail : techneshanghai@techne.cn

## Techné Turquie

Phone : +90 (0) 212 256 68 96  
Fax : +90 (0) 212 255 21 92  
Mail : turkey@techne.fr

## Creat

Phone : +33 (0)4 37 46 20 01  
Fax : +33 (0)4 37 46 20 10  
Mail : creat@creat.fr

ISO 9001  
ISO 14001  
BUREAU VERITAS  
Certification



ISO 9100  
BUREAU VERITAS  
Certification



**techne.fr**